

1

2

3

4

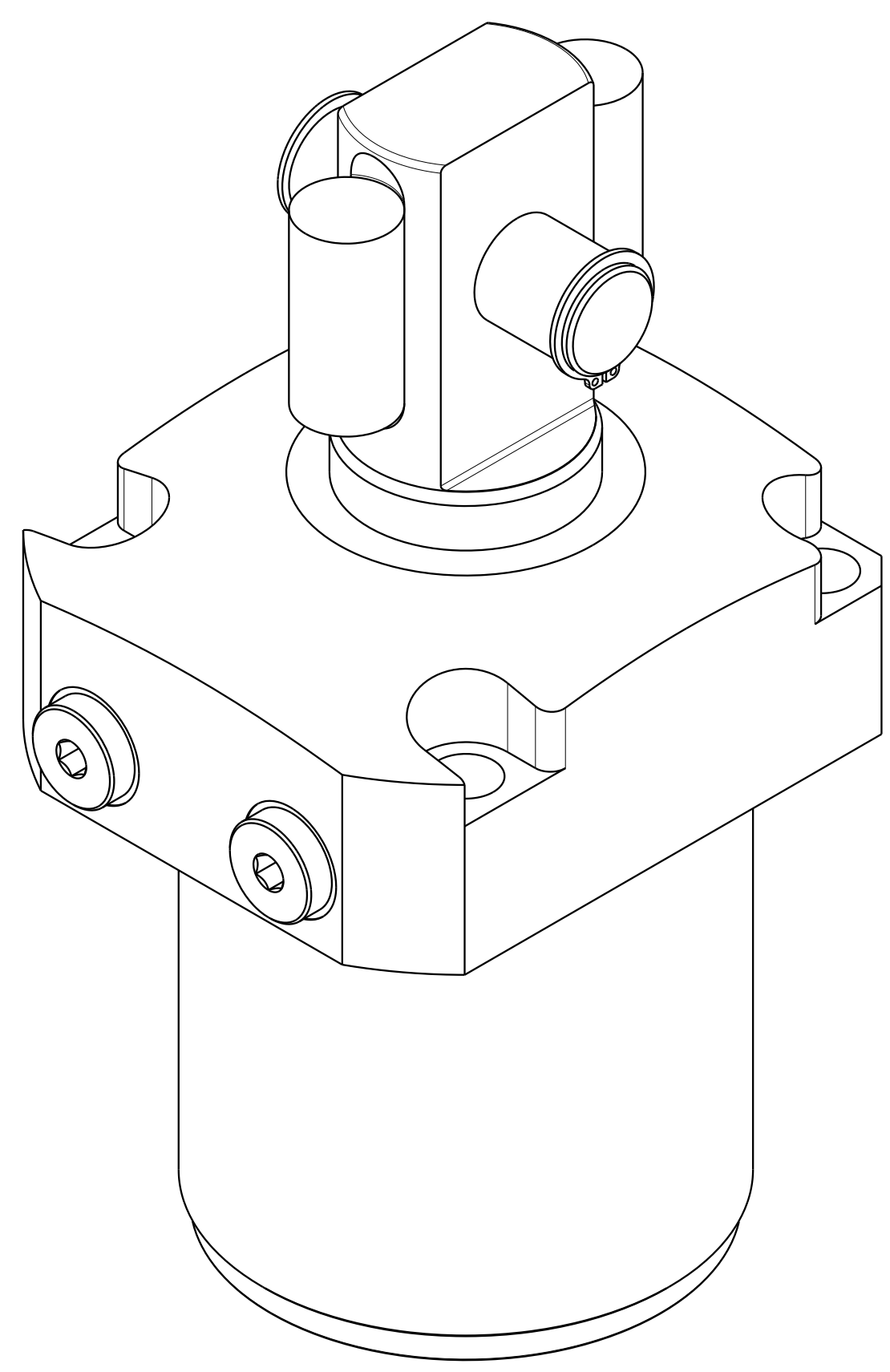
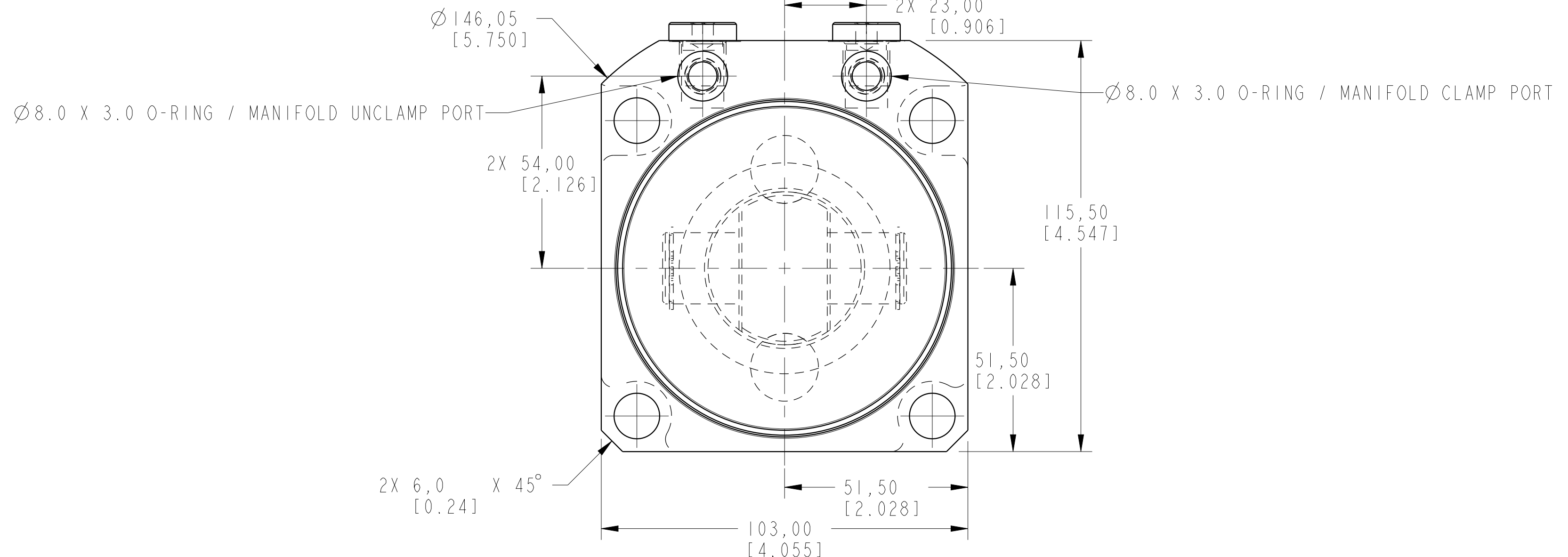

ILCML1408010R90 REV A ECN 2714

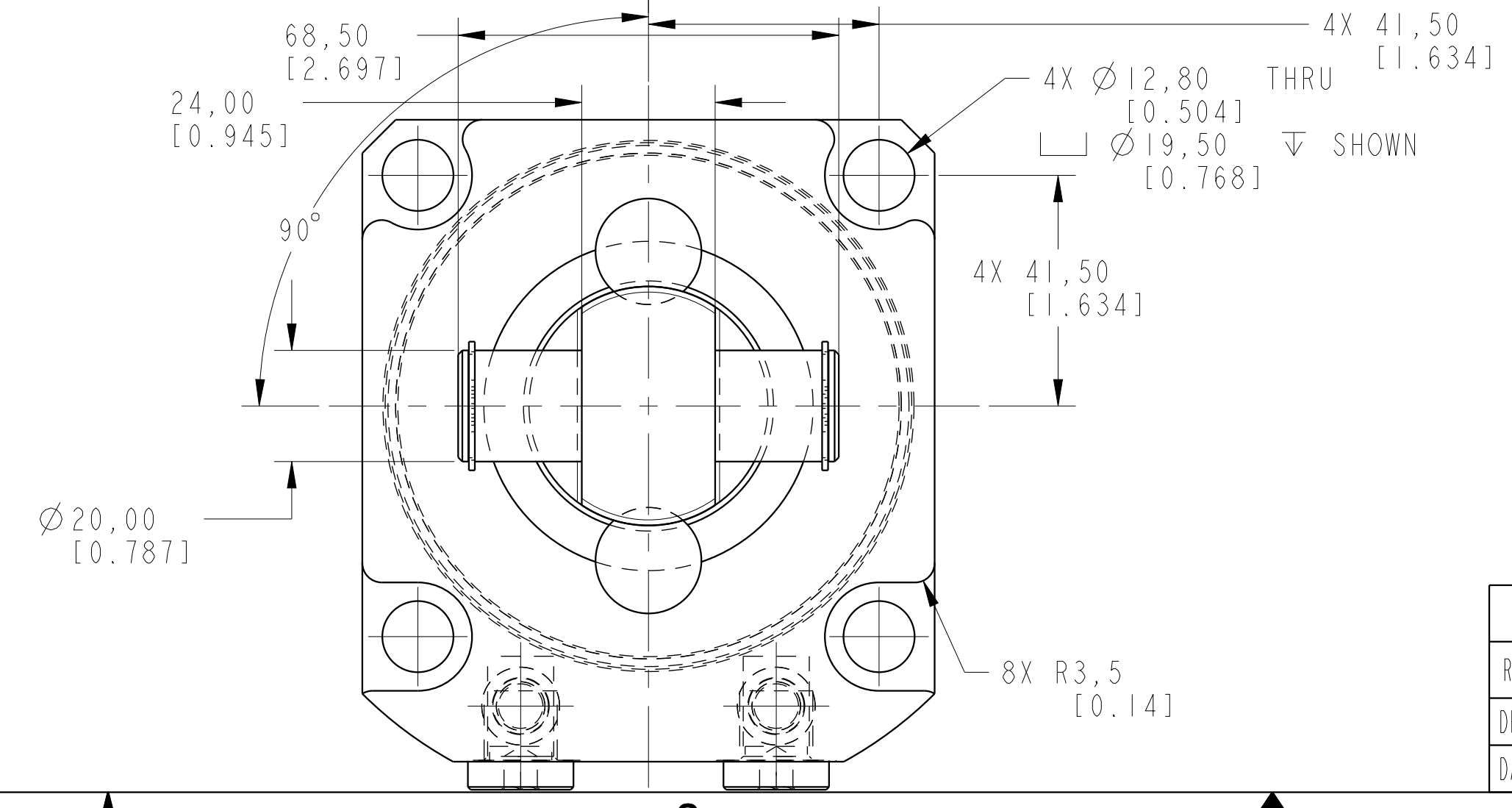
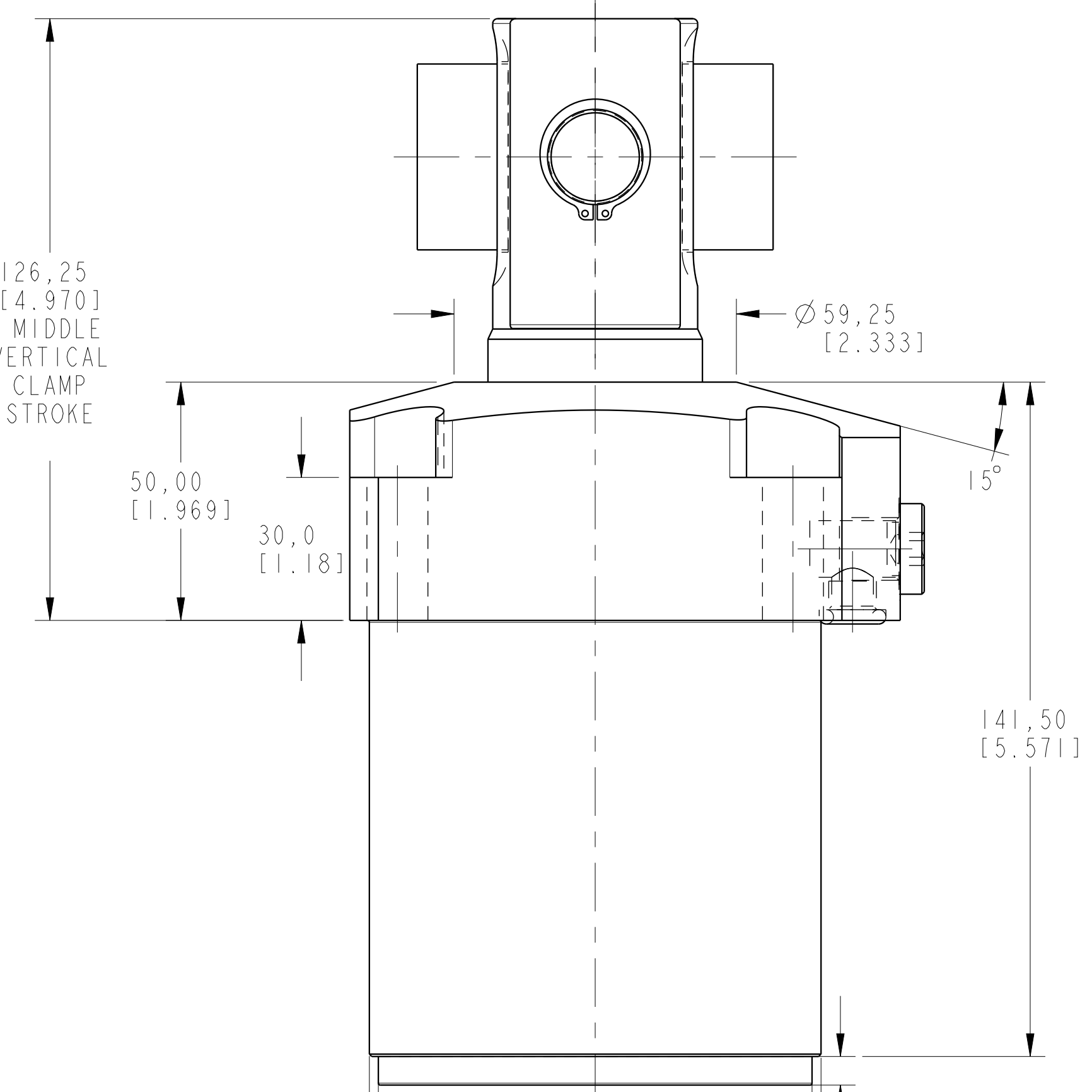
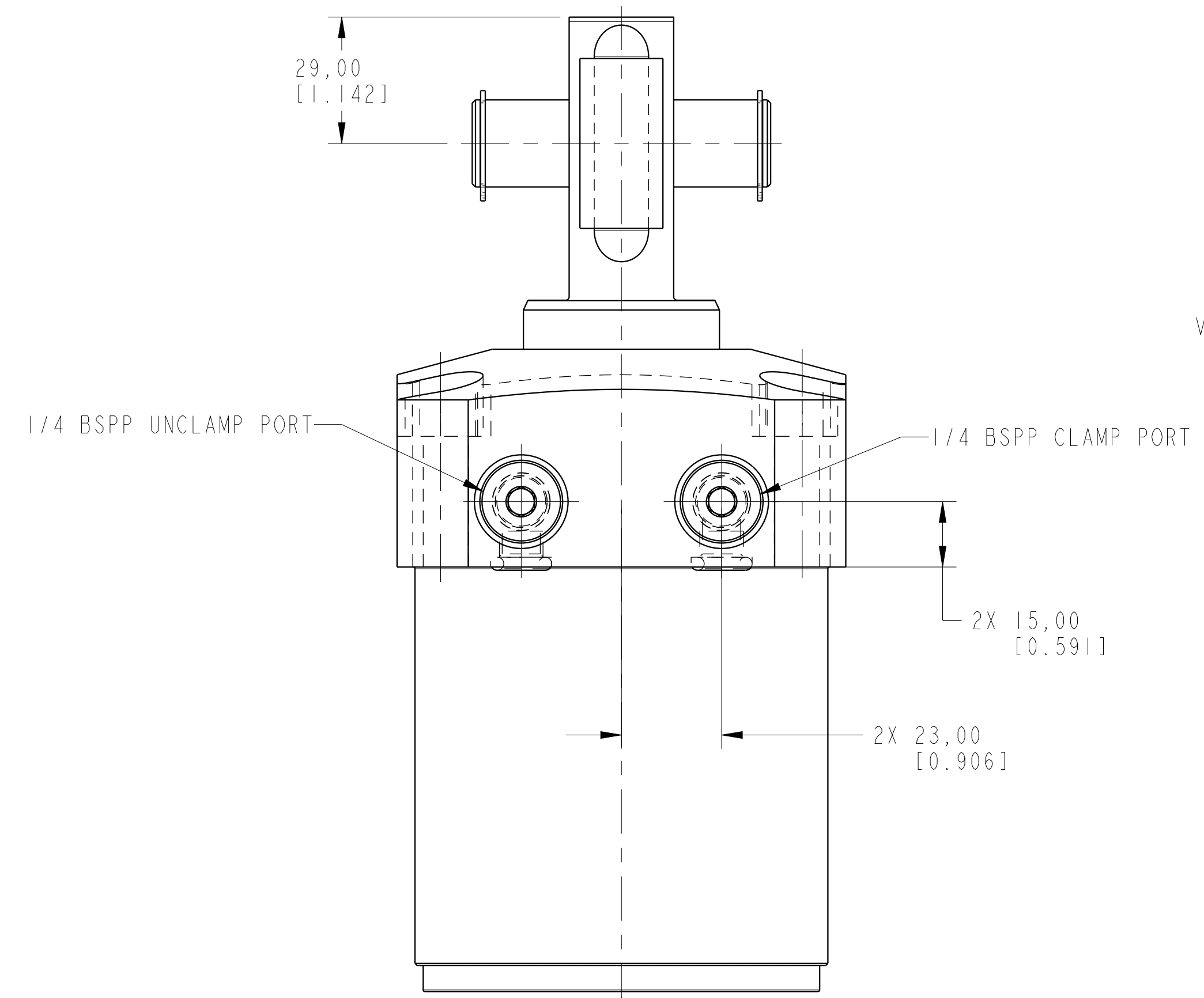
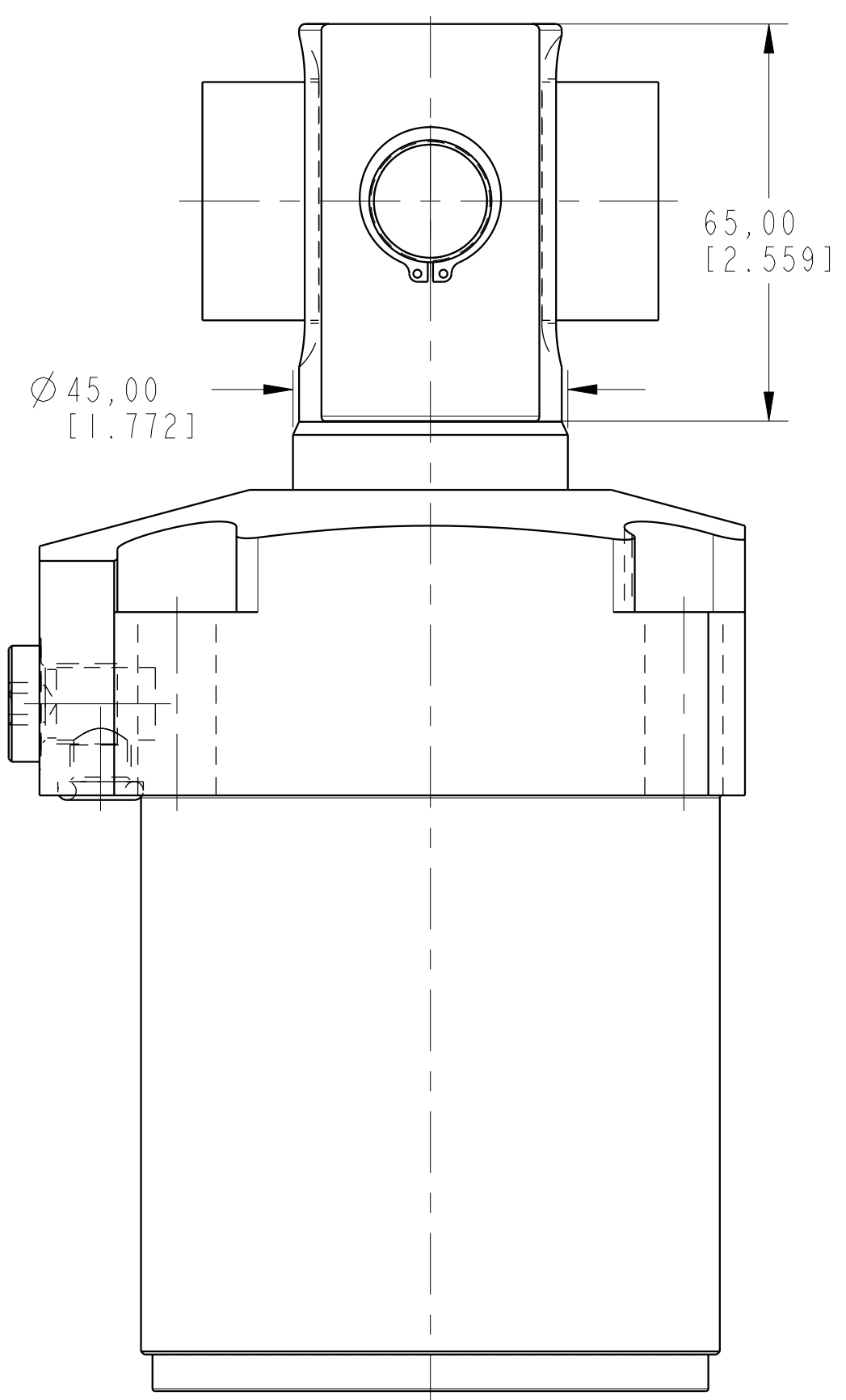

CAD CONTROL DRAWING



VEKTEK, INC.
1334 E. SIXTH AVE. P.O. BOX 625
EMPORIA, KS. 66801 U.S.A.

A	2714	RELEASE	MAJ	3-25-15
REV	IN ACCORDANCE WITH ECN	EFFECTIVE DATE	REVISED BY	DATE
DRW BY:	ALUTHI	DRAWING STATUS: Released		
DATE:	8-13-14	PRODUCTION APPROVED FOR RELEASED STATUS ONLY		

LI-4080-10-R-90	A	SC, TF, 7MPa, 80B, RH, CLEVIS, 90
REFERENCE MODEL	REF REV	*****
TOLERANCES DO NOT APPLY DIMENSIONS ARE NOMINAL		

SIZE	D	ILCML1408010R90	REV	A
FORM FEG036, Rev. B				

1

2

3

4

SHEET 1 OF 1