

ILCML1413210S0 REV A ECN 2714

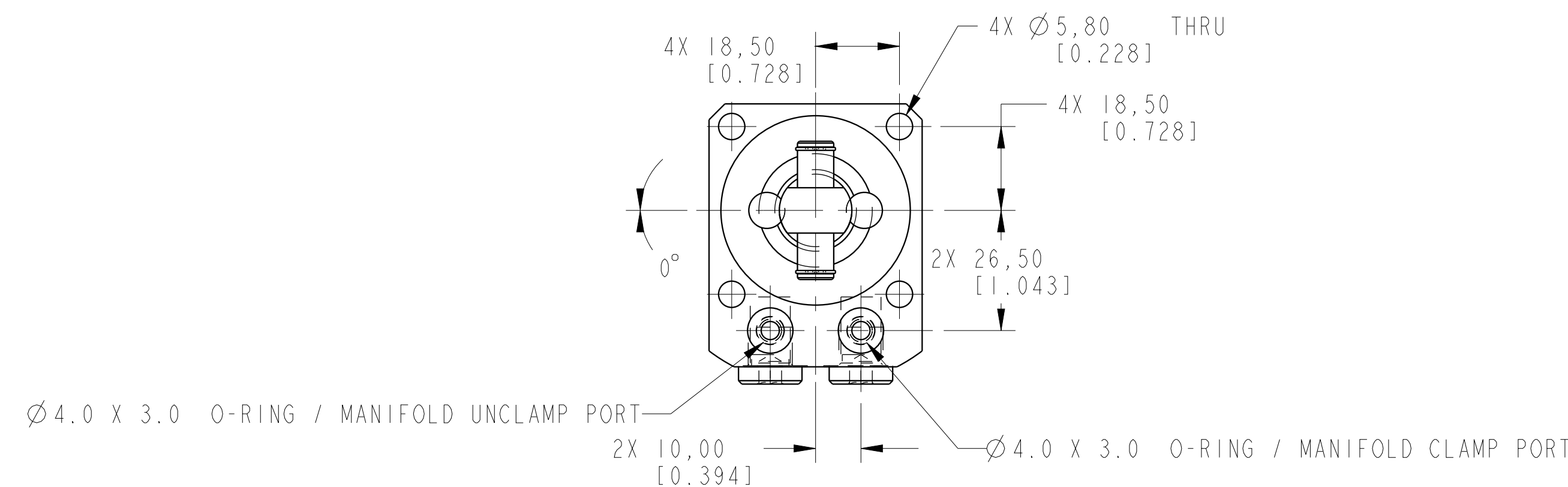
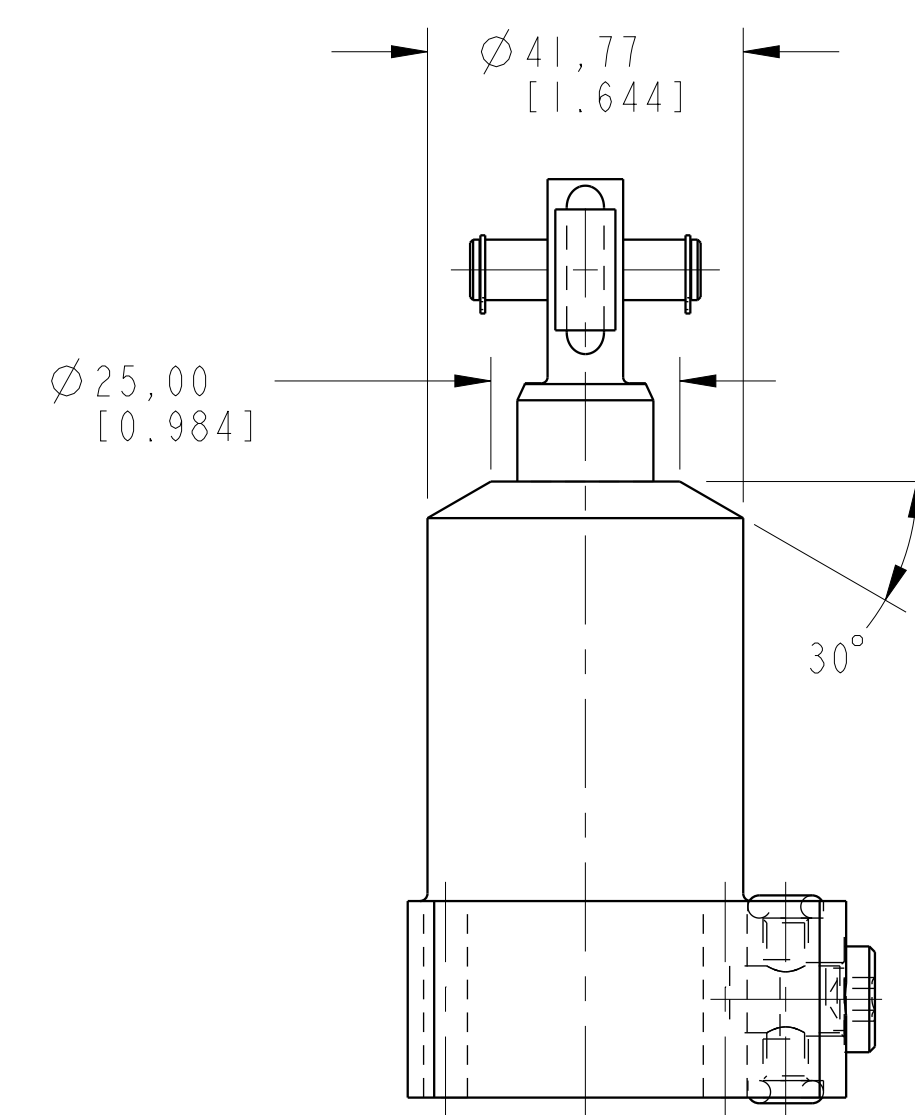
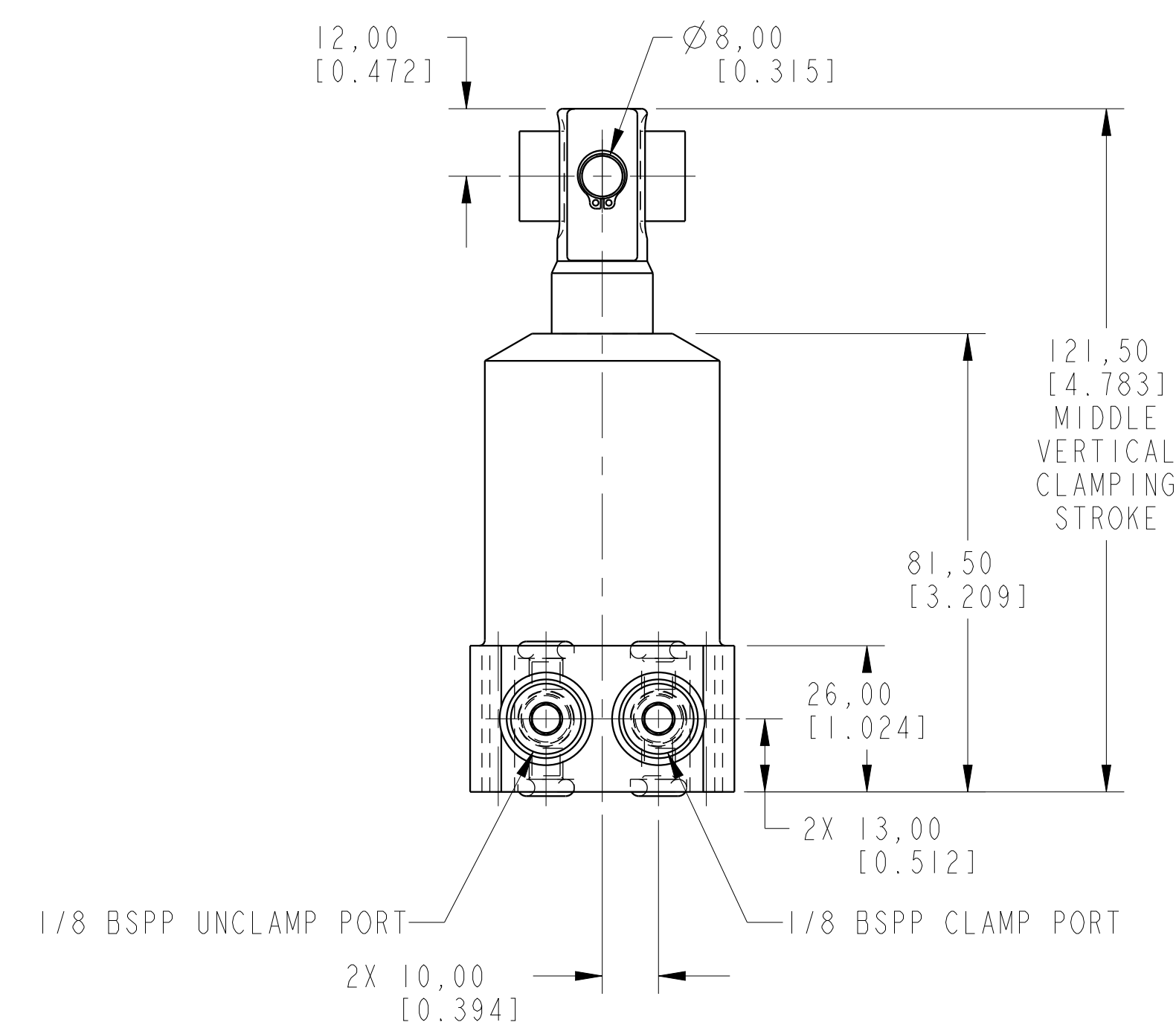
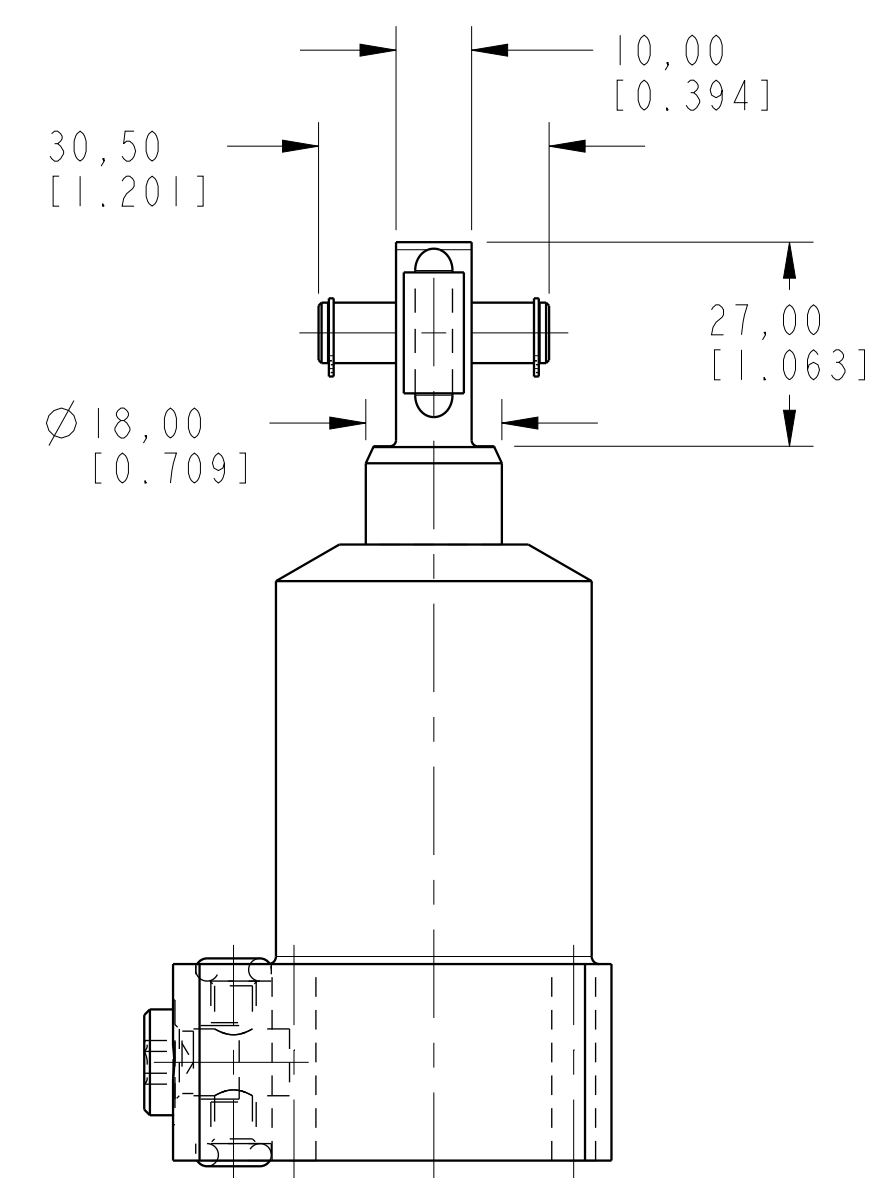

CAD CONTROL DRAWING		
	VEKTEK, INC. 1334 E. SIXTH AVE. P.O. BOX 625 EMPORIA, KS. 66801 U.S.A.	

A	2714	RELEASE	MAJ	3-25-15	LI-4132-10-S-0	A	SC, BF, 7MPa, 32B, STR, CLEVIS, 0
REV	IN ACCORDANCE WITH ECN	EFFECTIVE DATE	REVISED BY	DATE	REFERENCE MODEL	REF REV	*****
DRW BY:	ALUTHI	DRAWING STATUS: Released			TOLERANCES DO NOT APPLY	UNITS	SIZE
DATE:	8-13-14	PRODUCTION APPROVED FOR RELEASED STATUS ONLY			DIMENSIONS ARE NOMINAL	mm (inch)	D
					ILCML1413210S0	REV	A