

1

2

3

4

D

D

C

C

B

B

A

A

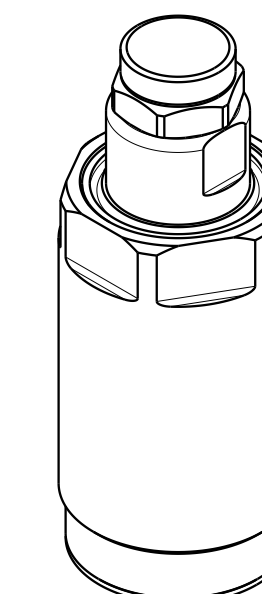

ILC10070810PS REV C ECN 4096

SCALE
1.000

SEE IS5003 FOR PART POSITION SENSOR SETUP

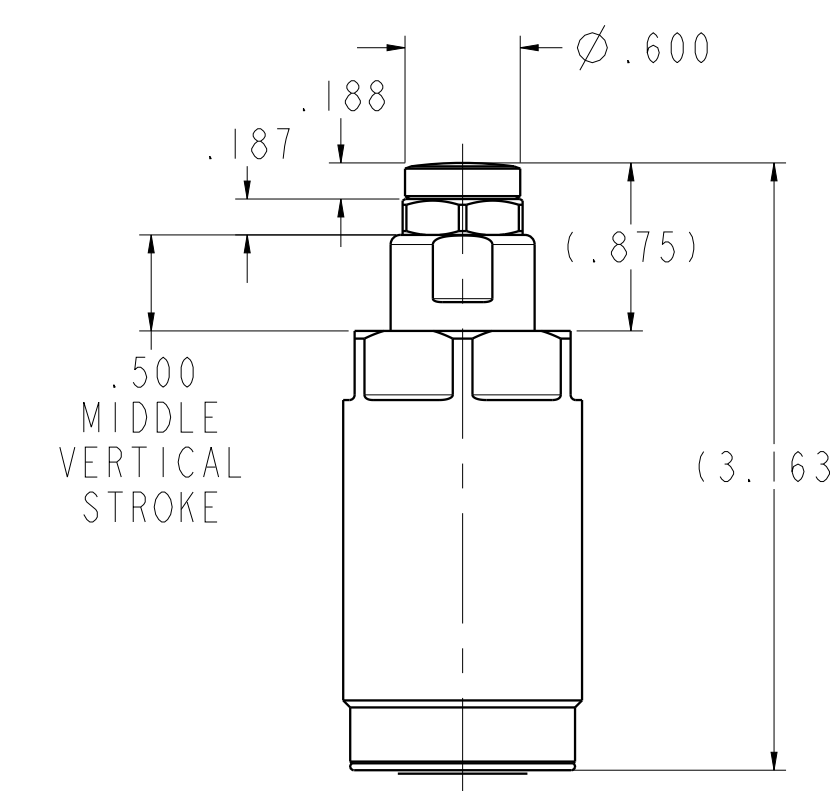
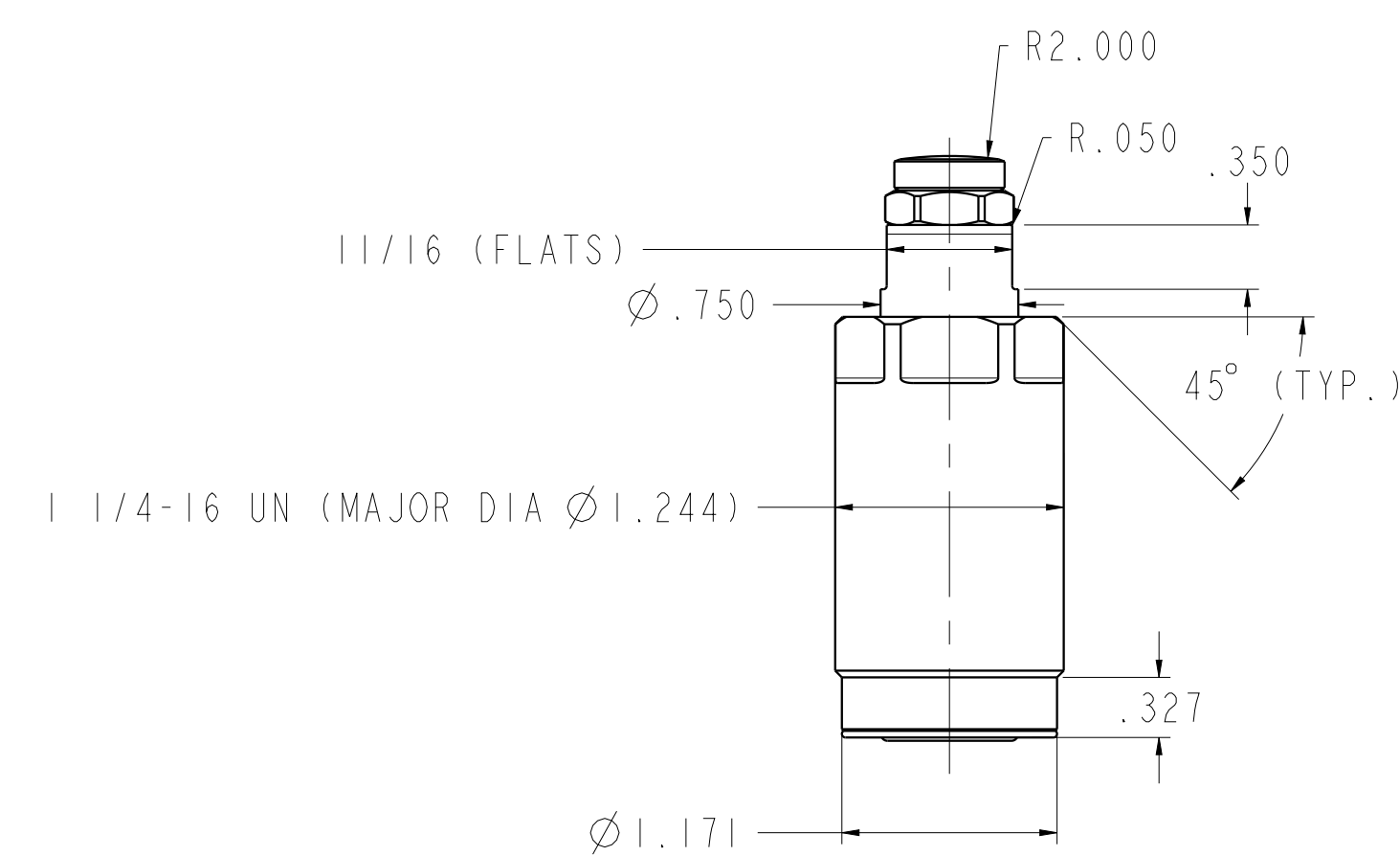
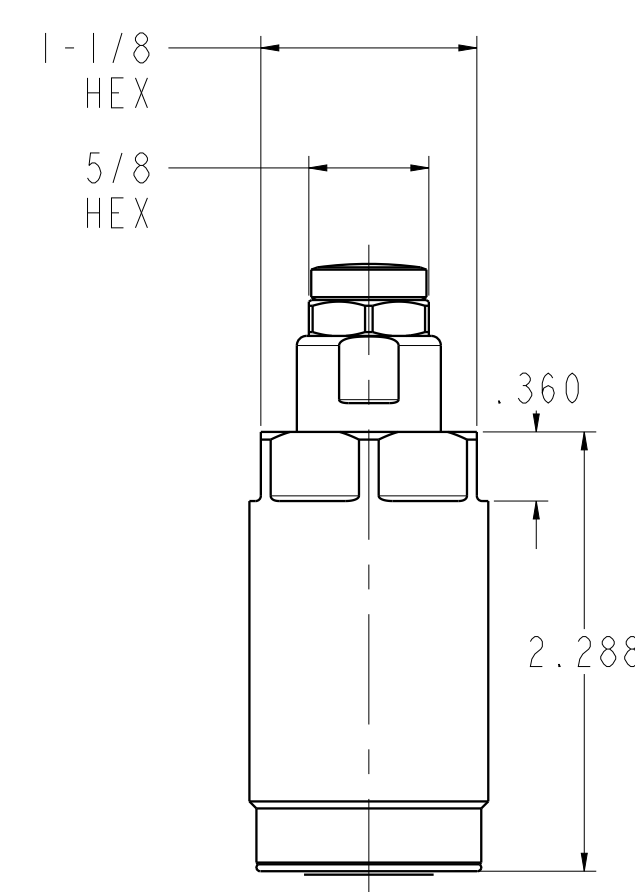
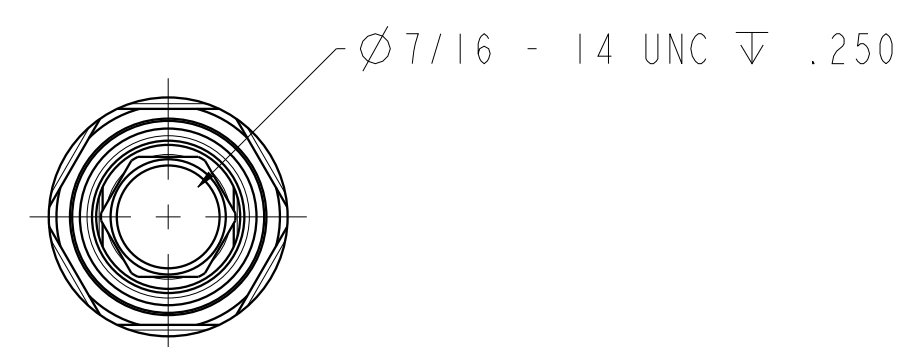

CAD CONTROL
DRAWING

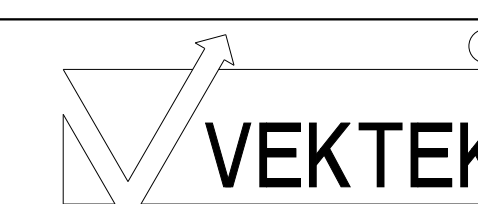

VEKTEK, INC.
1334 E. SIXTH AVE. P.O. BOX 625
EMPORIA, KS. 66801 U.S.A.

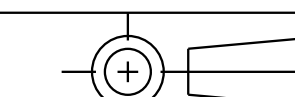

C	4096	RELEASE	MJUST	3/5/20	10070810PS	B	WS, FA, CM, HC, 4000, PPS
REV	IN ACCORDANCE WITH ECN	EFFECTIVE DATE	REVISED BY	DATE	REFERENCE MODEL	REF REV	
DRW BY:	BCD	DRAWING STATUS: Released			TOLERANCES DO NOT APPLY DIMENSIONS ARE NOMINAL		SIZE D
DATE:	30-Aug-18	PRODUCTION APPROVED FOR RELEASED STATUS ONLY			ILC10070810PS	REV C	

1

2

3

4

SHEET 1 OF 1