

1

2

3

4

D

D

C

C

B

B

A

A

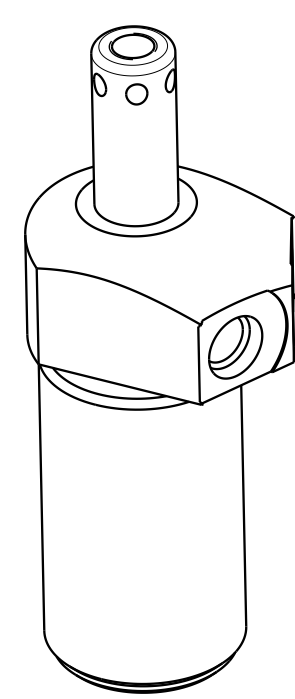
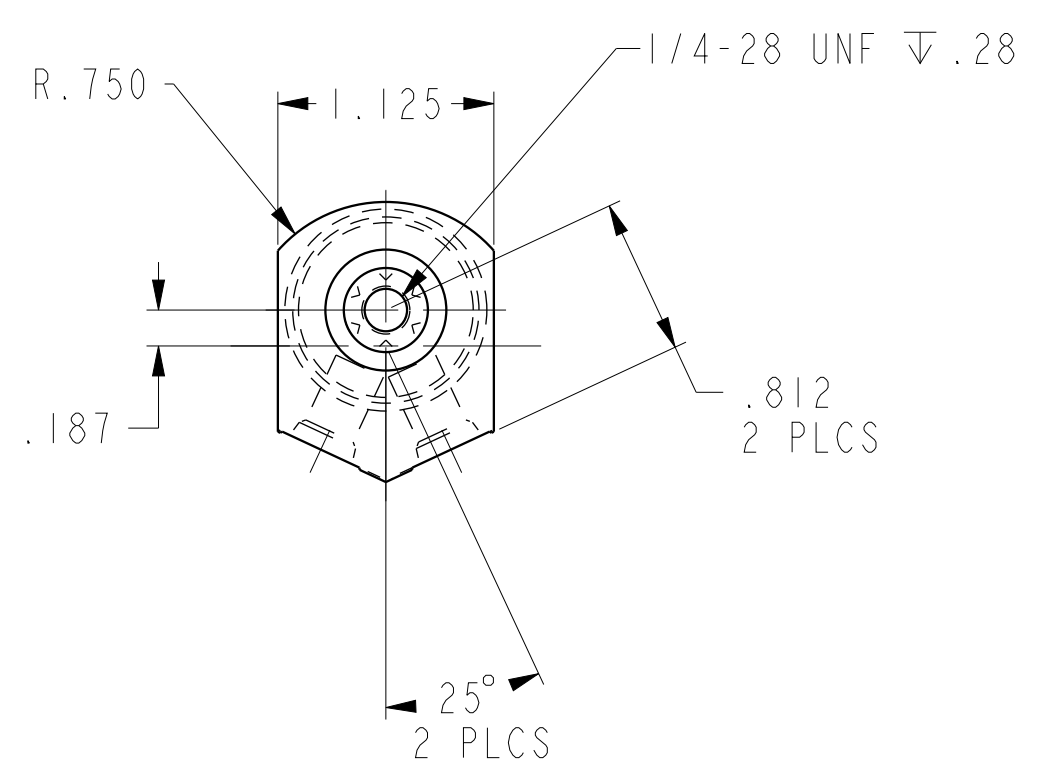

ILC14020501S REV A ECN 3396

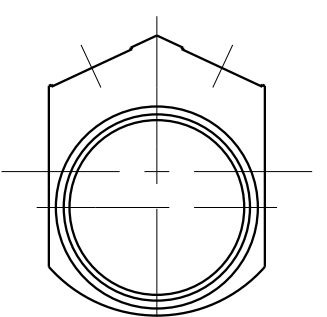
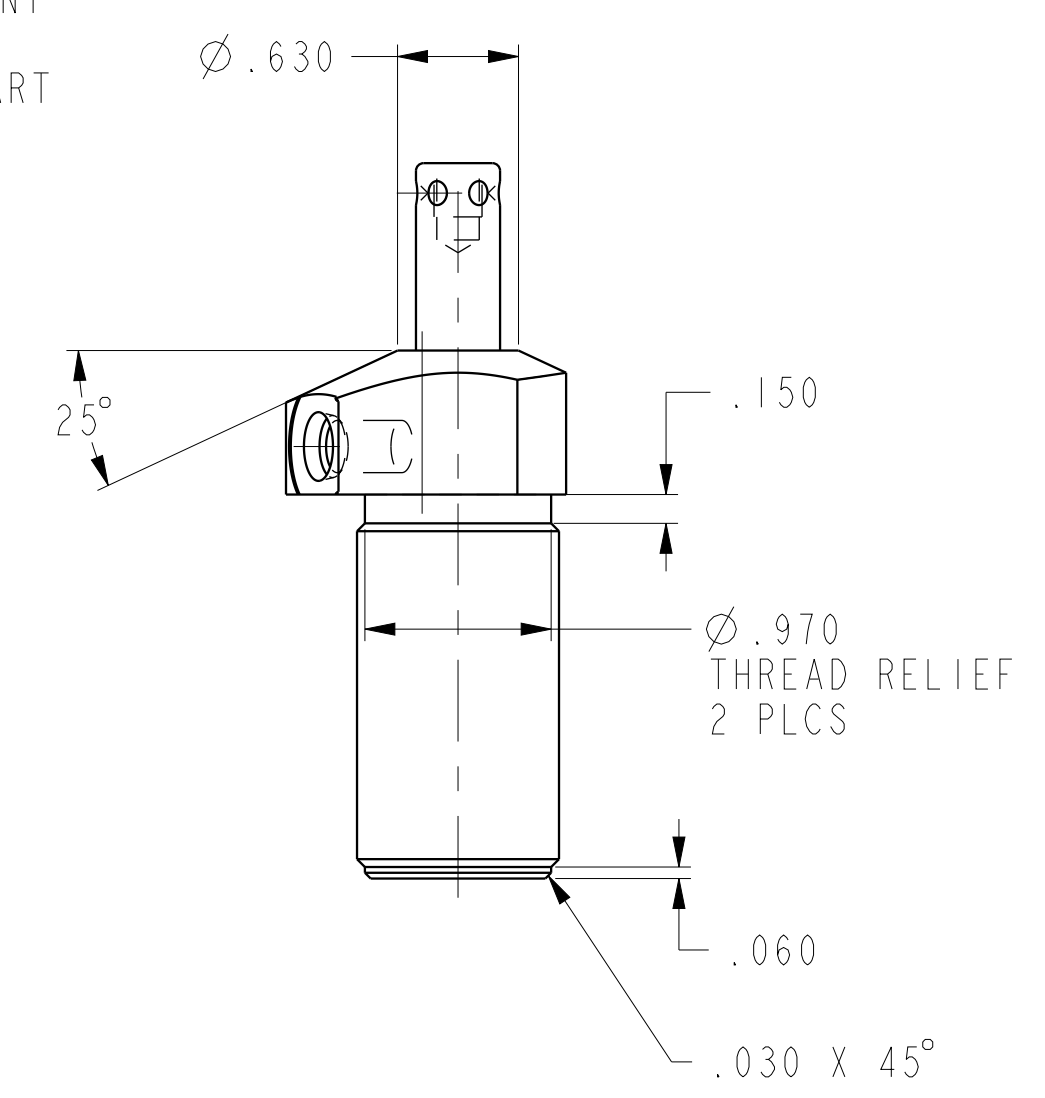
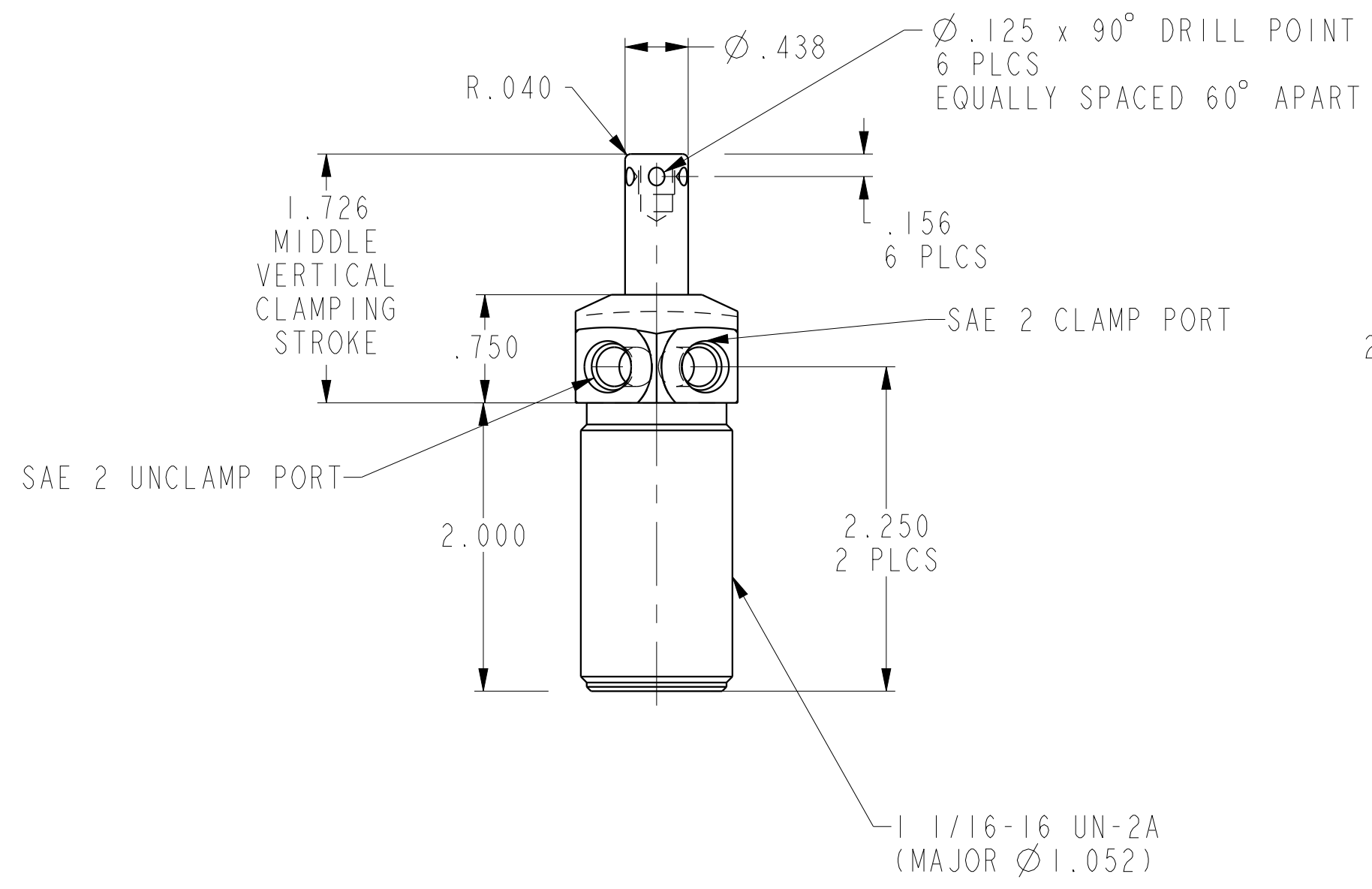

CAD CONTROL DRAWING

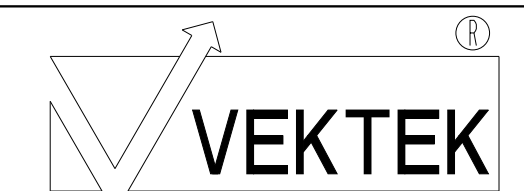

VEKTEK, INC.
1334 E. SIXTH AVE. P.O. BOX 625
EMPORIA, KS. 66801 U.S.A.

A	3396	RELEASE	JDW	01/17/18
REV	IN ACCORDANCE WITH ECN	EFFECTIVE DATE	REVISED BY	DATE
DRW BY:	JDW	DRAWING STATUS: Released		
DATE:	01/17/18	PRODUCTION APPROVED FOR RELEASED STATUS ONLY		

14020501S	A
REFERENCE MODEL	REF REV
TOLERANCES DO NOT APPLY DIMENSIONS ARE NOMINAL	

SIZE	D	REV	A
ILC14020501S			

1

2

3

4

SHEET 1 OF 1