

1

2

3

4

D

D

C

C

B

B

A

A

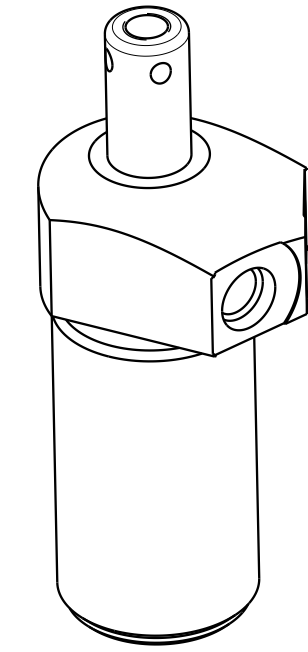
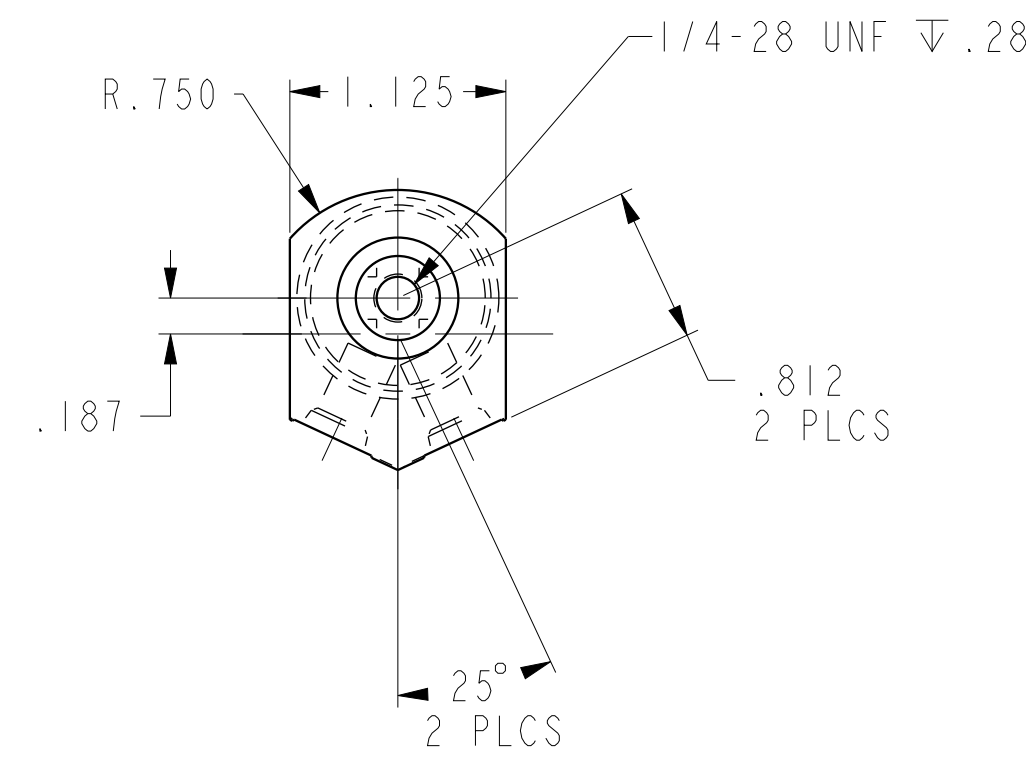

ILC15020503R REV A ECN 4609

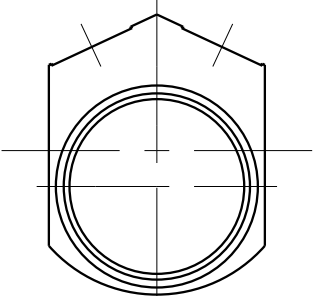
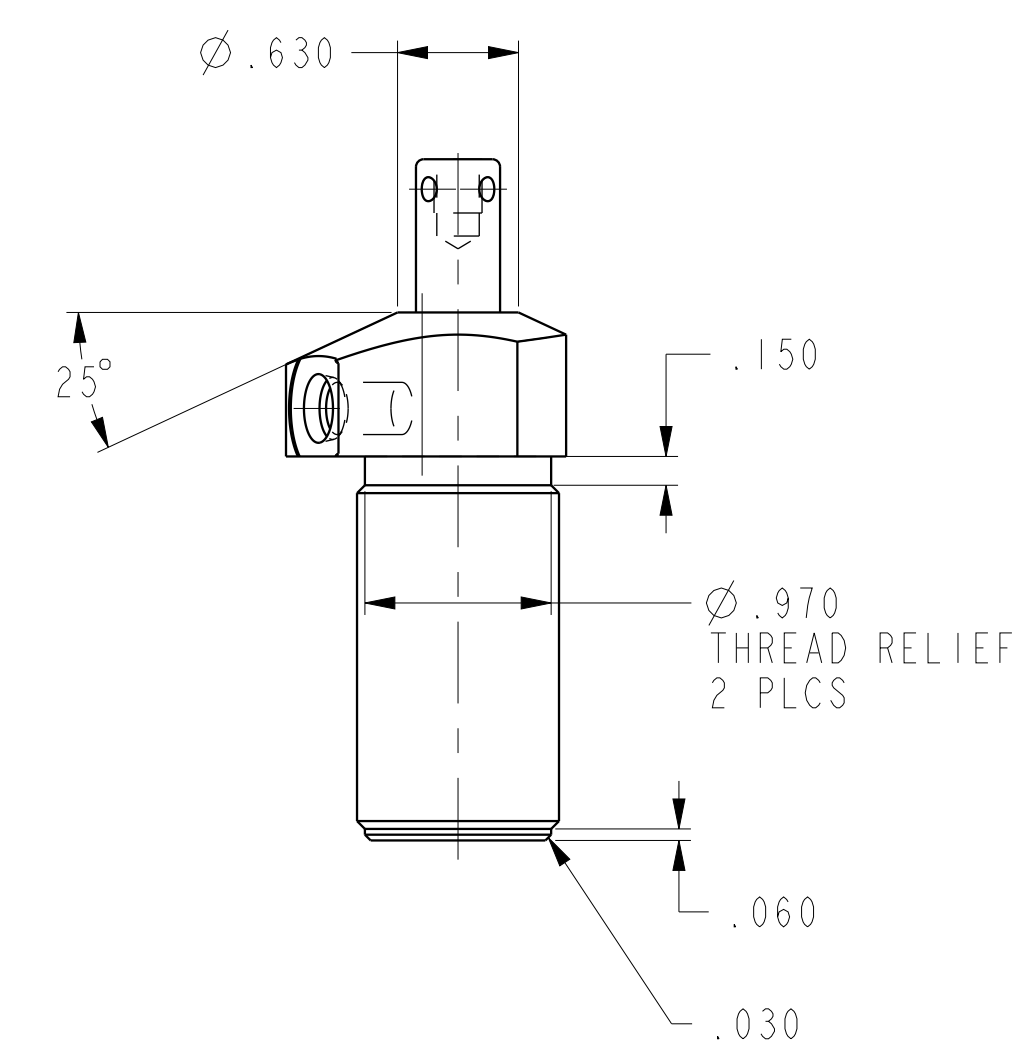
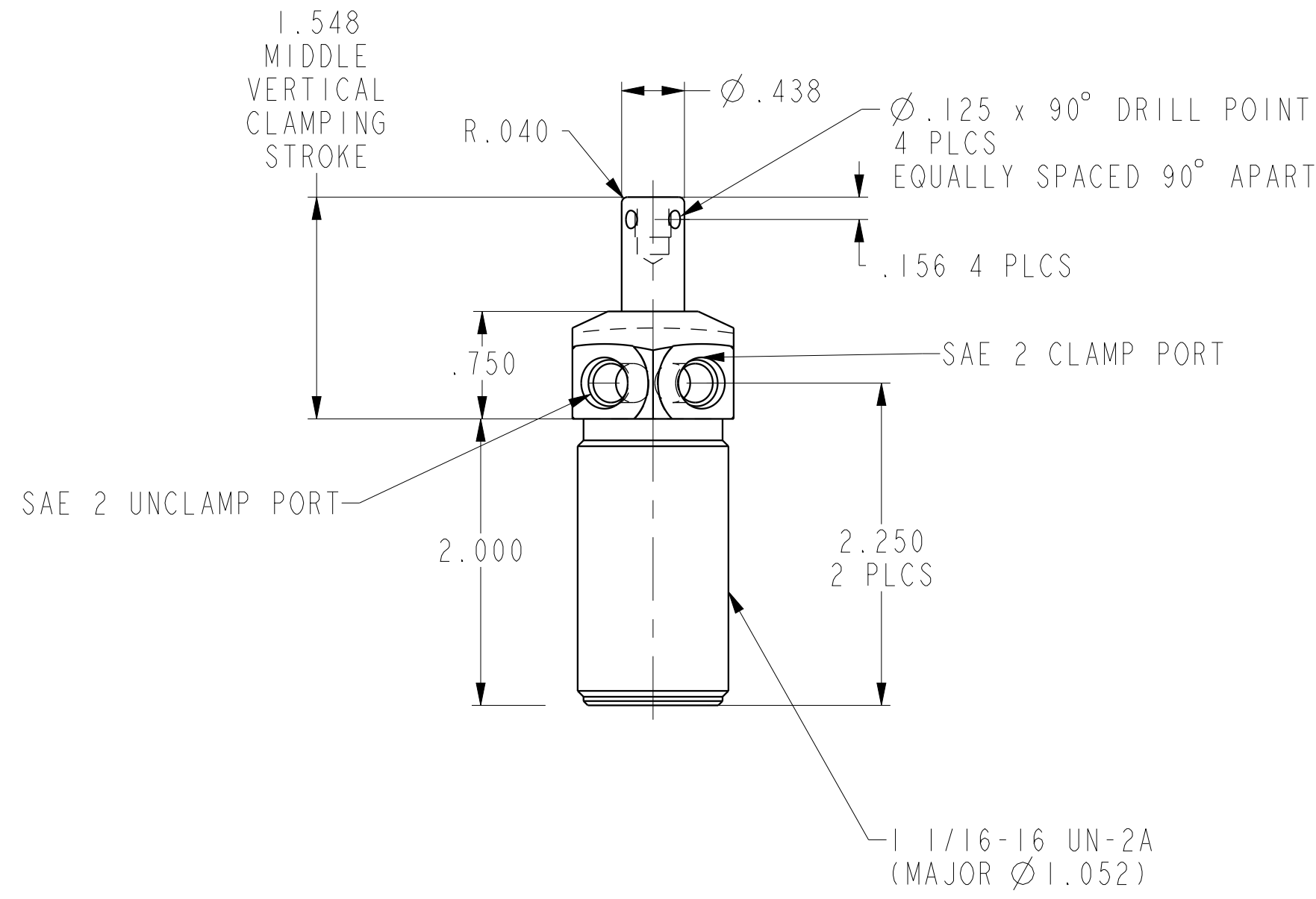

CAD CONTROL DRAWING

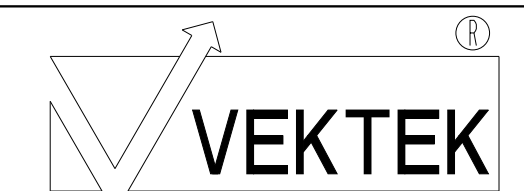

VEKTEK, INC.
1334 E. SIXTH AVE. P.O. BOX 625
EMPORIA, KS. 66801 U.S.A.

A	4609	RELEASE	RLK	1/20/22
REV	IN ACCORDANCE WITH ECN	EFFECTIVE DATE	REVISED BY	DATE
DRW BY:	RLK	DRAWING STATUS: Released		
DATE:	1/20/22	PRODUCTION APPROVED FOR RELEASED STATUS ONLY		

15020503R	A
REFERENCE MODEL	REF REV
TOLERANCES DO NOT APPLY DIMENSIONS ARE NOMINAL	

SIZE	D	REV	A
ILC15020503R			

1

2

3

4

SHEET 1 OF 1