

ILC21410601 REV B ECN 4055

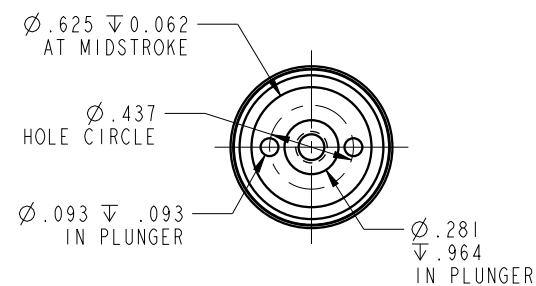

NOTE: RETURN SPRING INCLUDED WITH CYLINDER.
 SPRING OMITTED FOR CLARITY

CAD CONTROL
 DRAWING

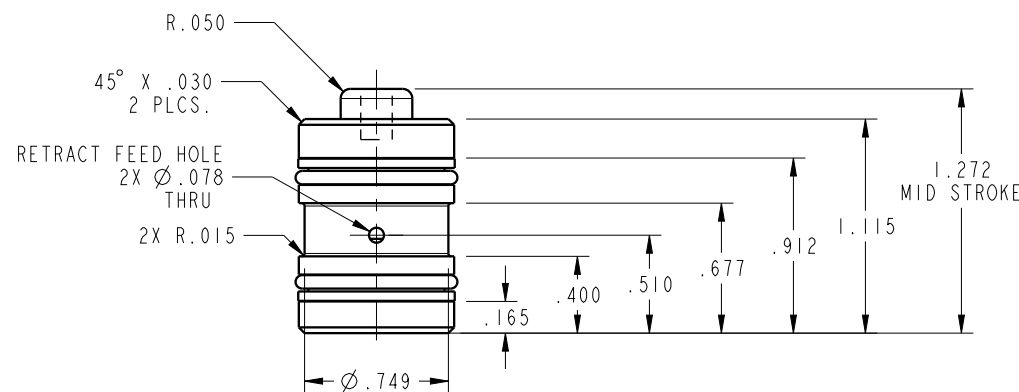

VEKTEK, INC.
 1334 E. SIXTH AVE. P.O. BOX 625
 EMPORIA, KS. 66801 U.S.A.

B	4055	RELEASE	MJUST	1/28/20	21410601	B	CYL, CM, PULL, 980LB
REV	IN ACCORDANCE WITH ECN	EFFECTIVE DATE	REVISED BY	DATE	REFERENCE MODEL	REF REV	8-32 THREAD
DRW BY: DKC	DRAWING STATUS: Released				TOLERANCES DO NOT APPLY	UNITS	SIZE
DATE: 8/21/14	PRODUCTION APPROVED FOR RELEASED STATUS ONLY				DIMENSIONS ARE NOMINAL	mm [inch]	B
							ILC21410601
							FORM FEG036, Rev. C

SHEET 1 OF 1