

ILCM41571122 REV A ECN 1498

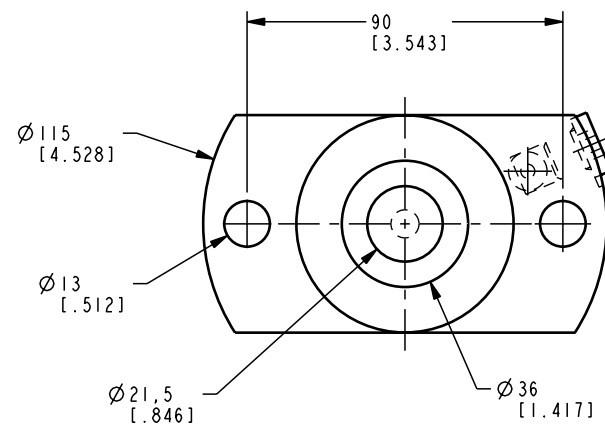

CAD CONTROL
DRAWING

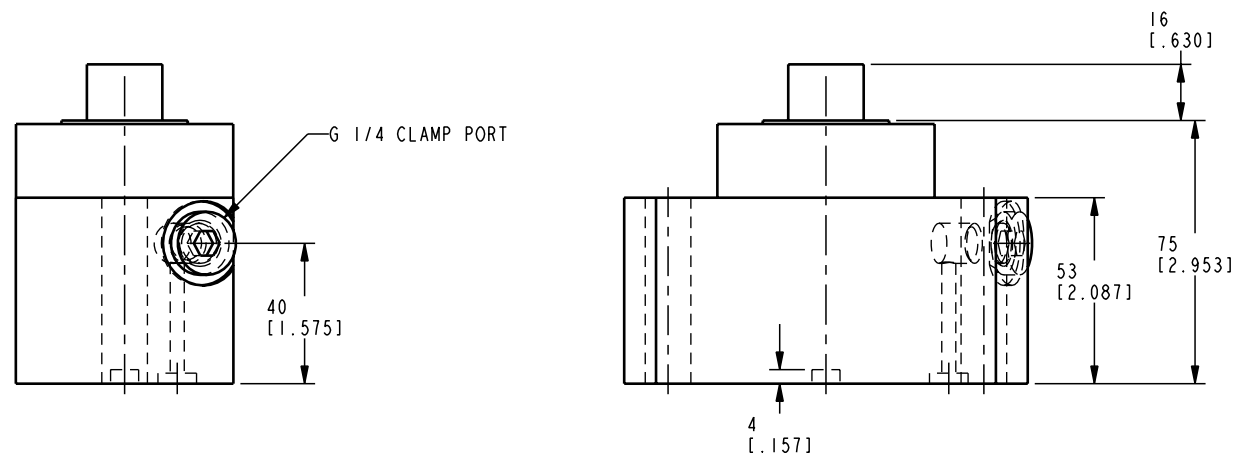

VEKTEK, INC.
1334 E. SIXTH AVE. P.O. BOX 625
EMPORIA, KS. 66801 U.S.A.

A	1498	RELEASE	K. ROEMER	05-10-06	41571122	A	CLAMP, PL DN, SA, 31 KN, 22MM, CNCTRC
REV	IN ACCORDANCE WITH ECN	EFFECTIVE DATE	REVISED BY	DATE	REFERENCE MODEL	REF REV	*****
DRW BY:	K. ROEMER	DRAWING STATUS: Released			TOLERANCES DO NOT APPLY	UNITS	SIZE
DATE:	05-10-06	PRODUCTION APPROVED FOR RELEASED STATUS ONLY			DIMENSIONS ARE NOMINAL	mm [inch]	D
						REV	A

FORM FEG036, Rev. B

SHEET 1 OF 1