

1

2

3

4

D

D

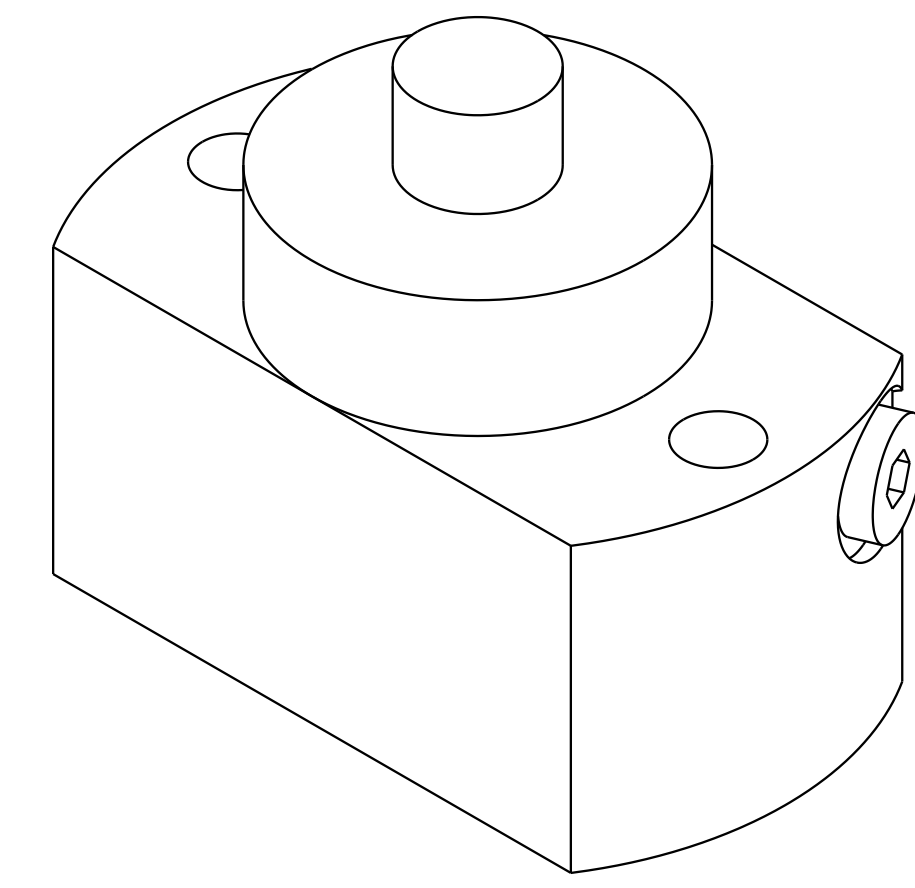
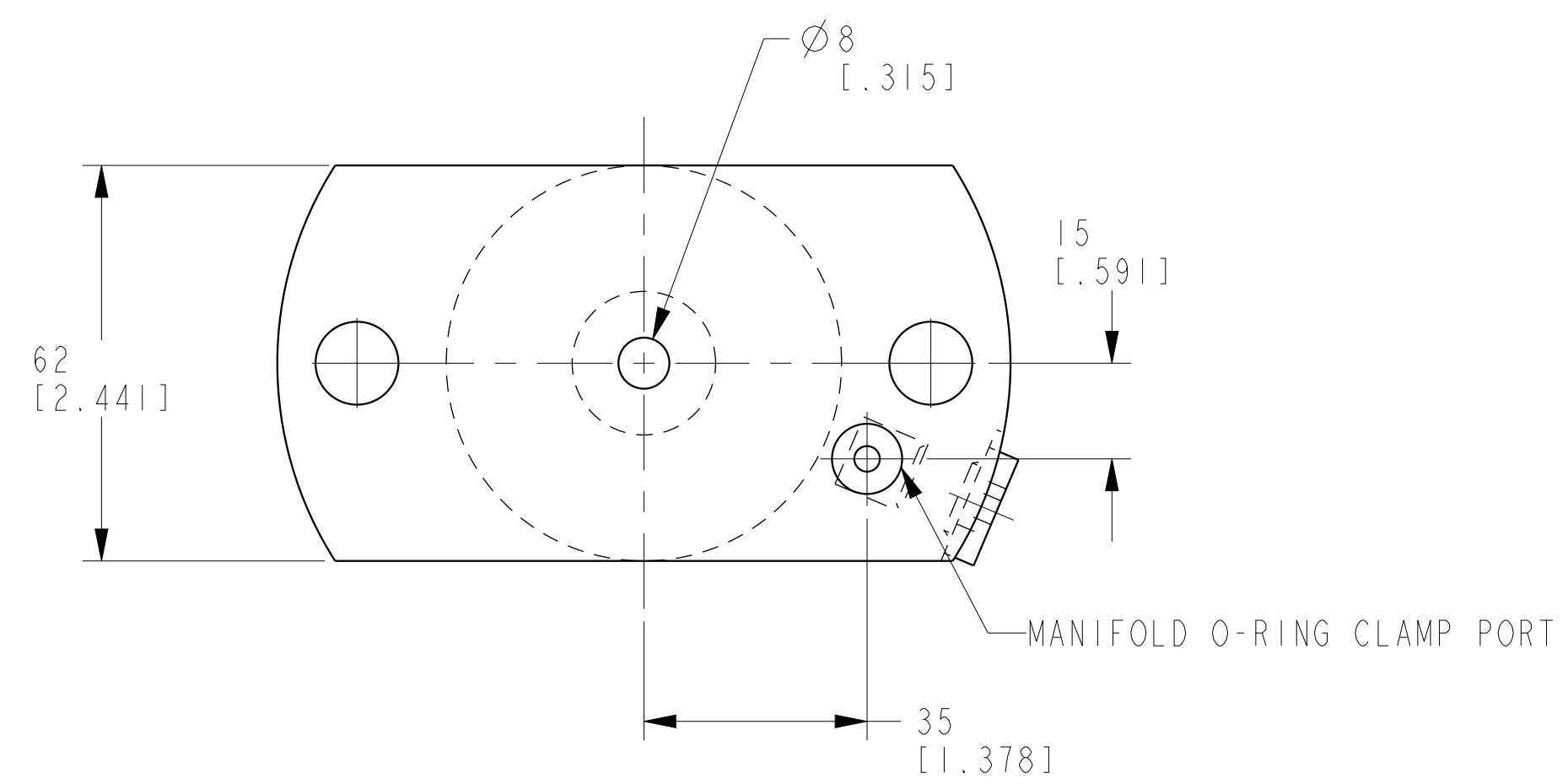

ILCM41571123 REV B ECN 5066

C

C

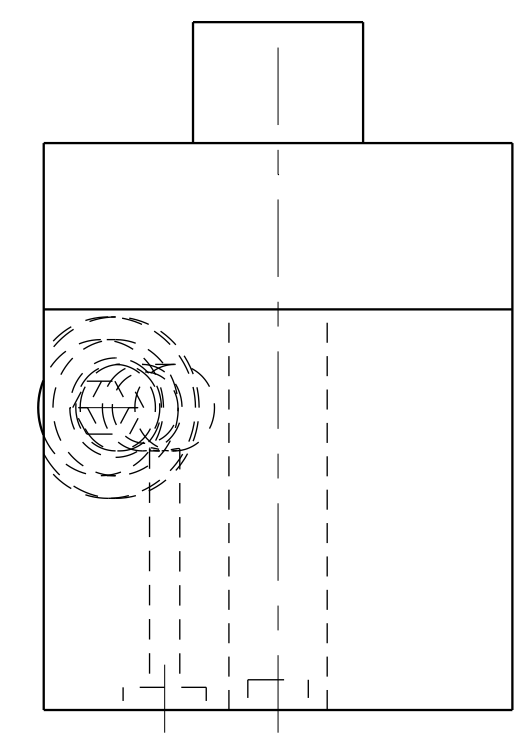
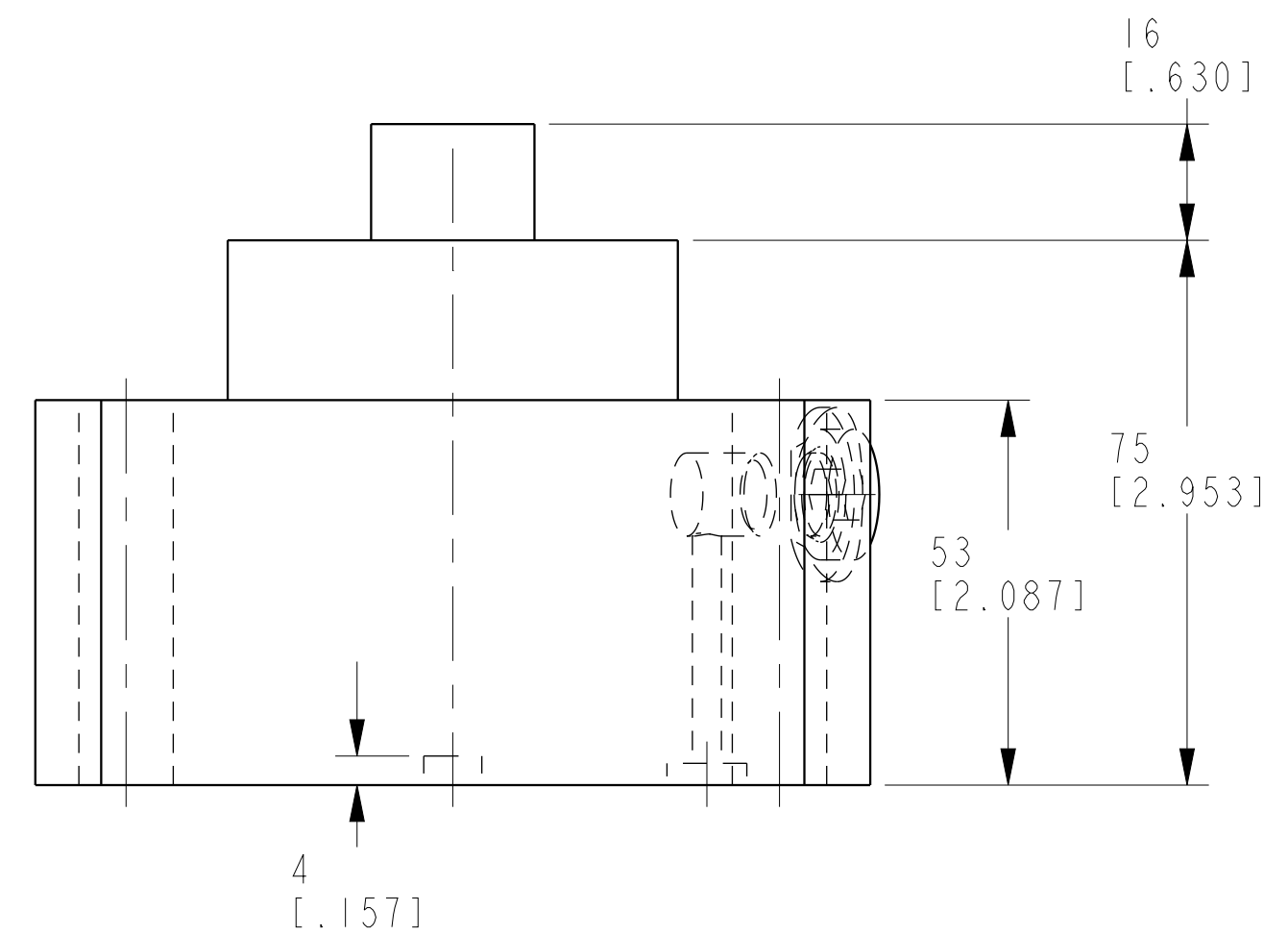
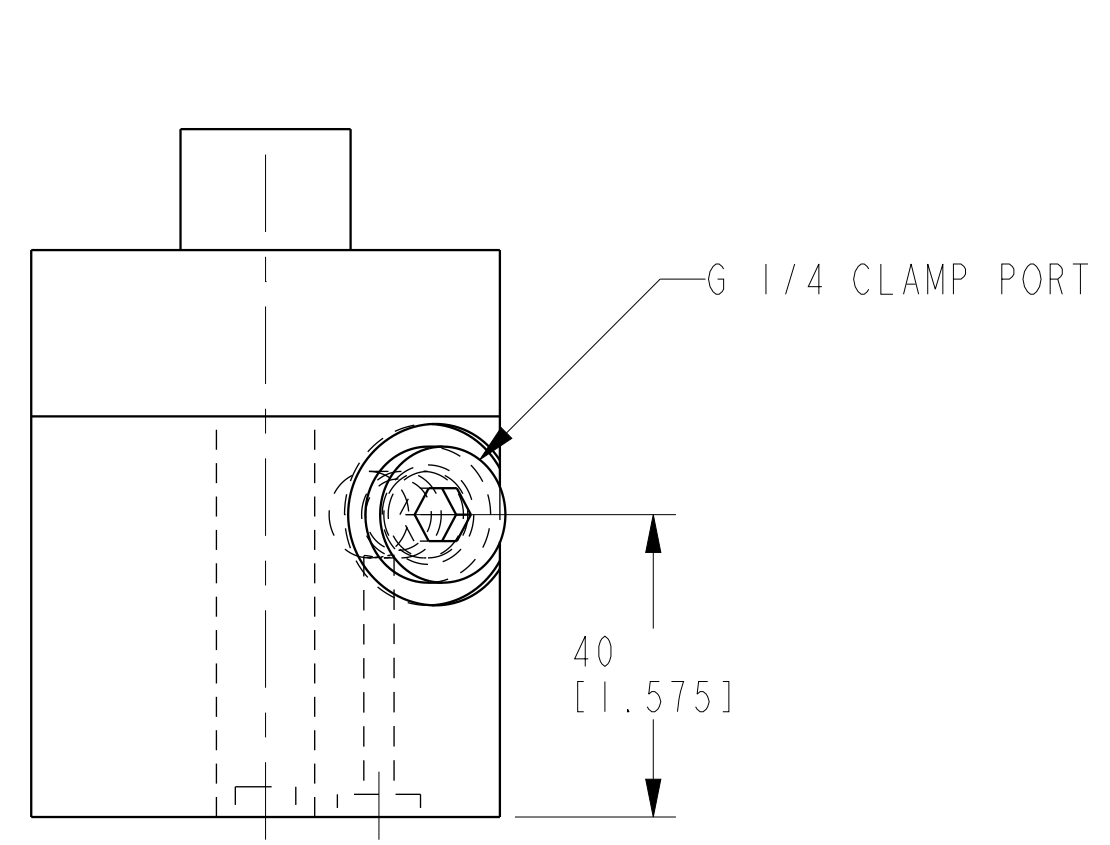

B

B

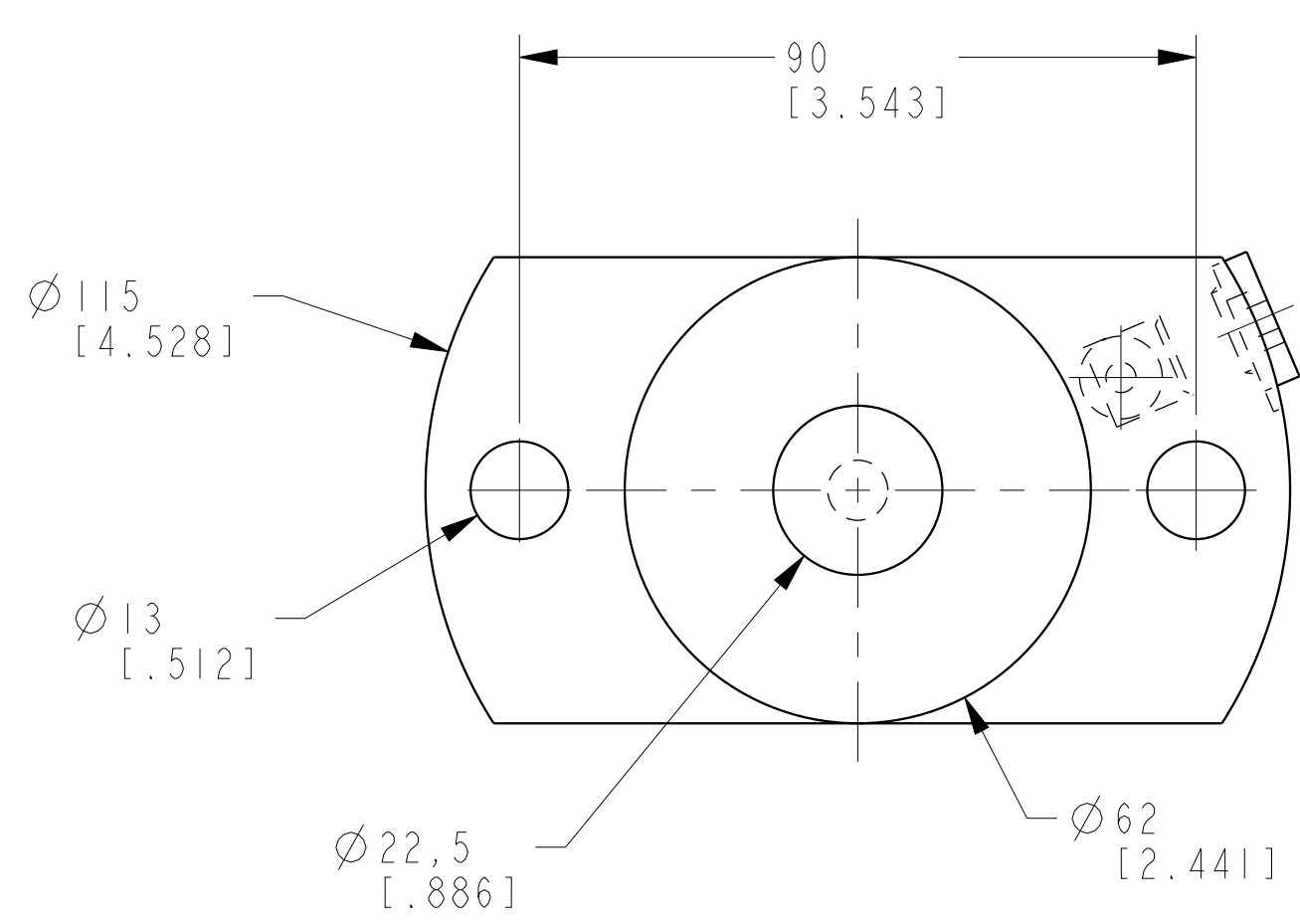

A

A

CAD CONTROL DRAWING

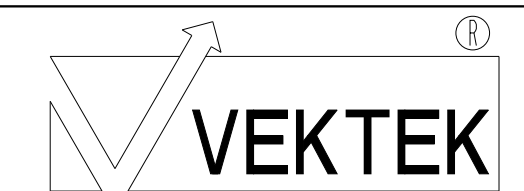

VEKTEK, INC.
1334 E. SIXTH AVE. P.O. BOX 625
EMPORIA, KS. 66801 U.S.A.

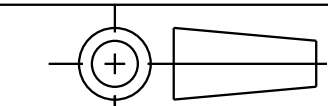

B	5066	RELEASE	RLK	4/5/23	41571123	A	CLAMP, PL DN, SA, 31 KN, 23MM, CNCTRC
REV	IN ACCORDANCE WITH ECN	EFFECTIVE DATE	REVISED BY	DATE	REFERENCE MODEL	REF REV	*****
DRW BY:	K. ROEMER	DRAWING STATUS: Released			TOLERANCES DO NOT APPLY	UNITS	SIZE
DATE:	05-10-06	PRODUCTION APPROVED FOR RELEASED STATUS ONLY			DIMENSIONS ARE NOMINAL	mm (inch)	D
					ILCM41571123	REV	B

1

2

3

4

SHEET 1 OF 1