

1

2

3

4

D

D

C

C

B

B

A

A

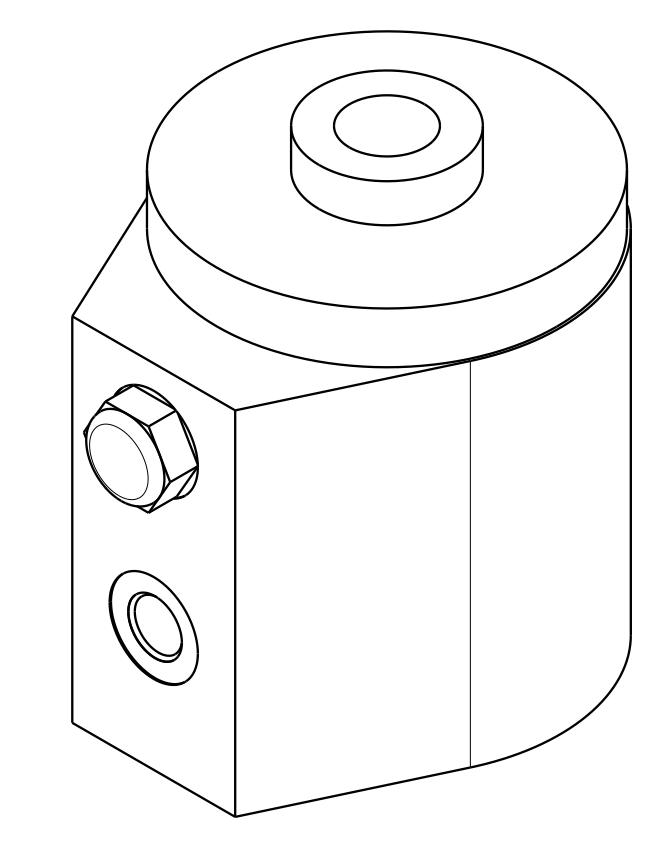
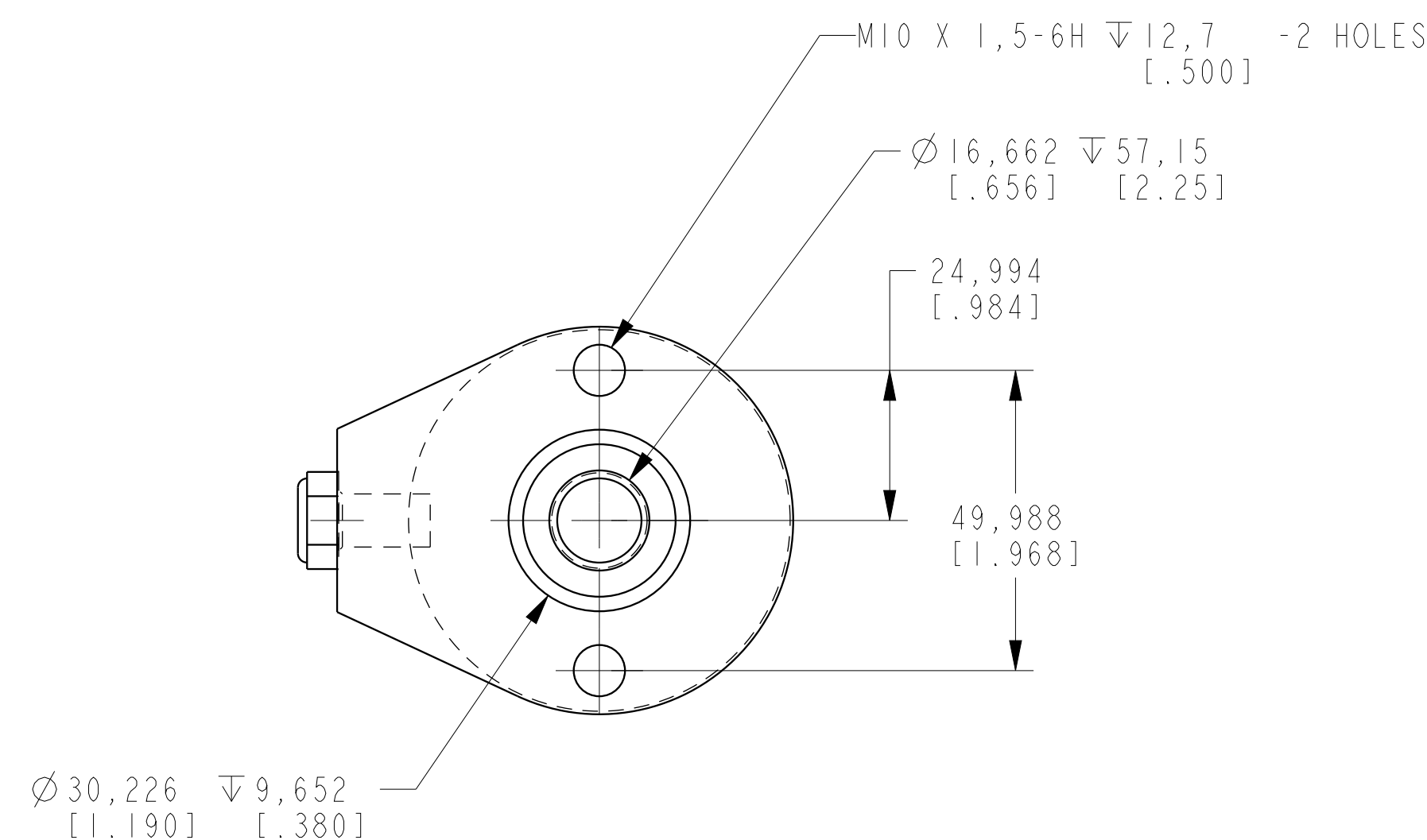

ILCM42021002 REV B ECN 3531

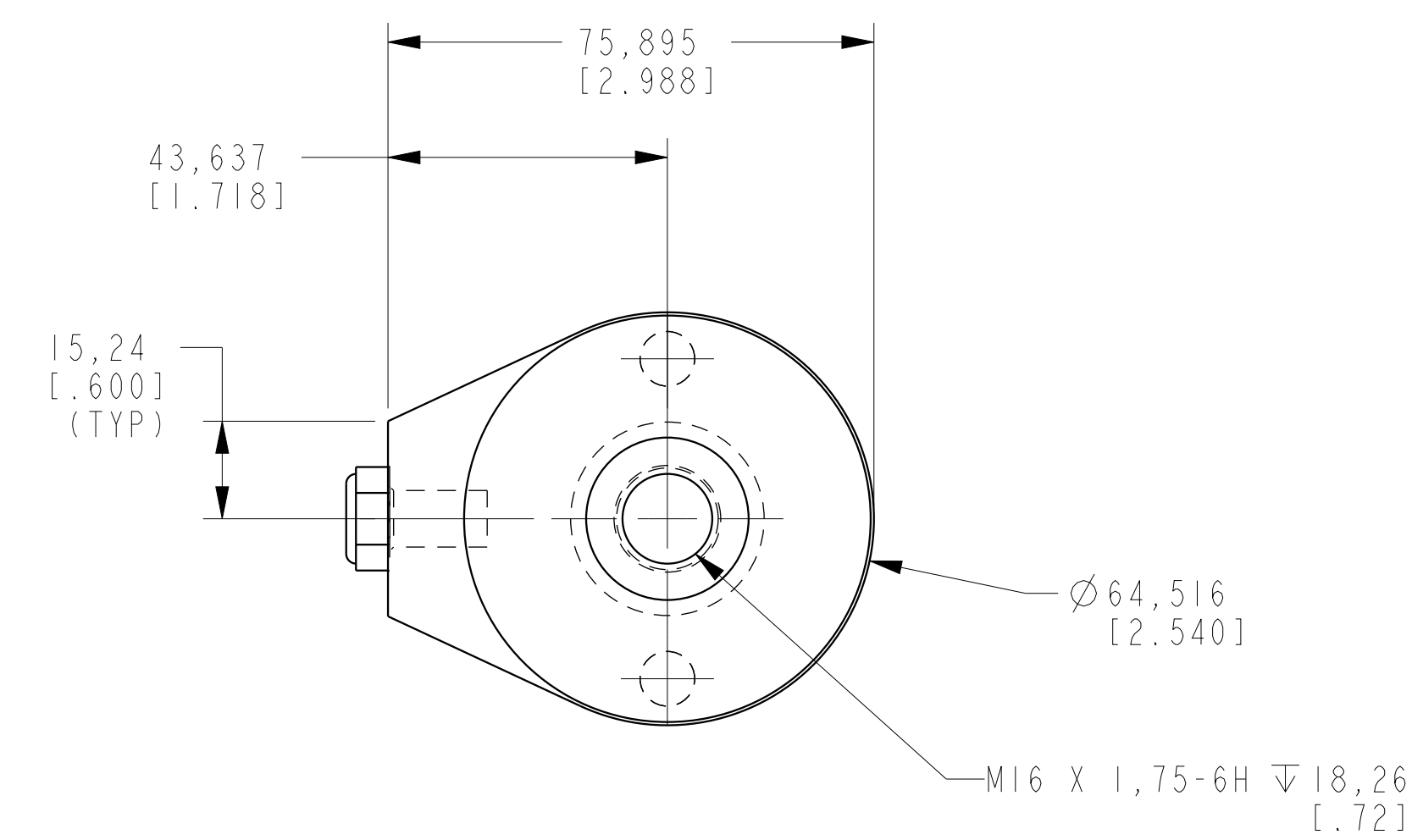
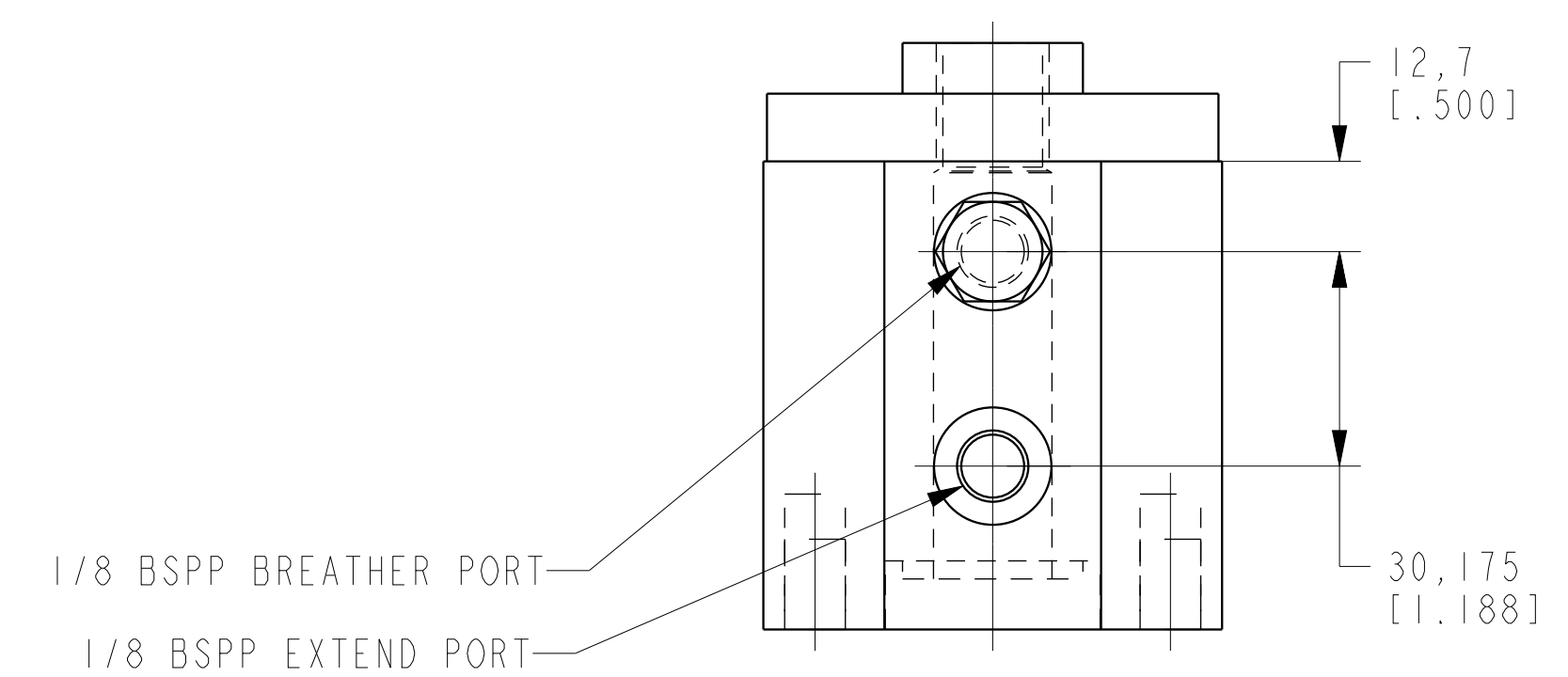
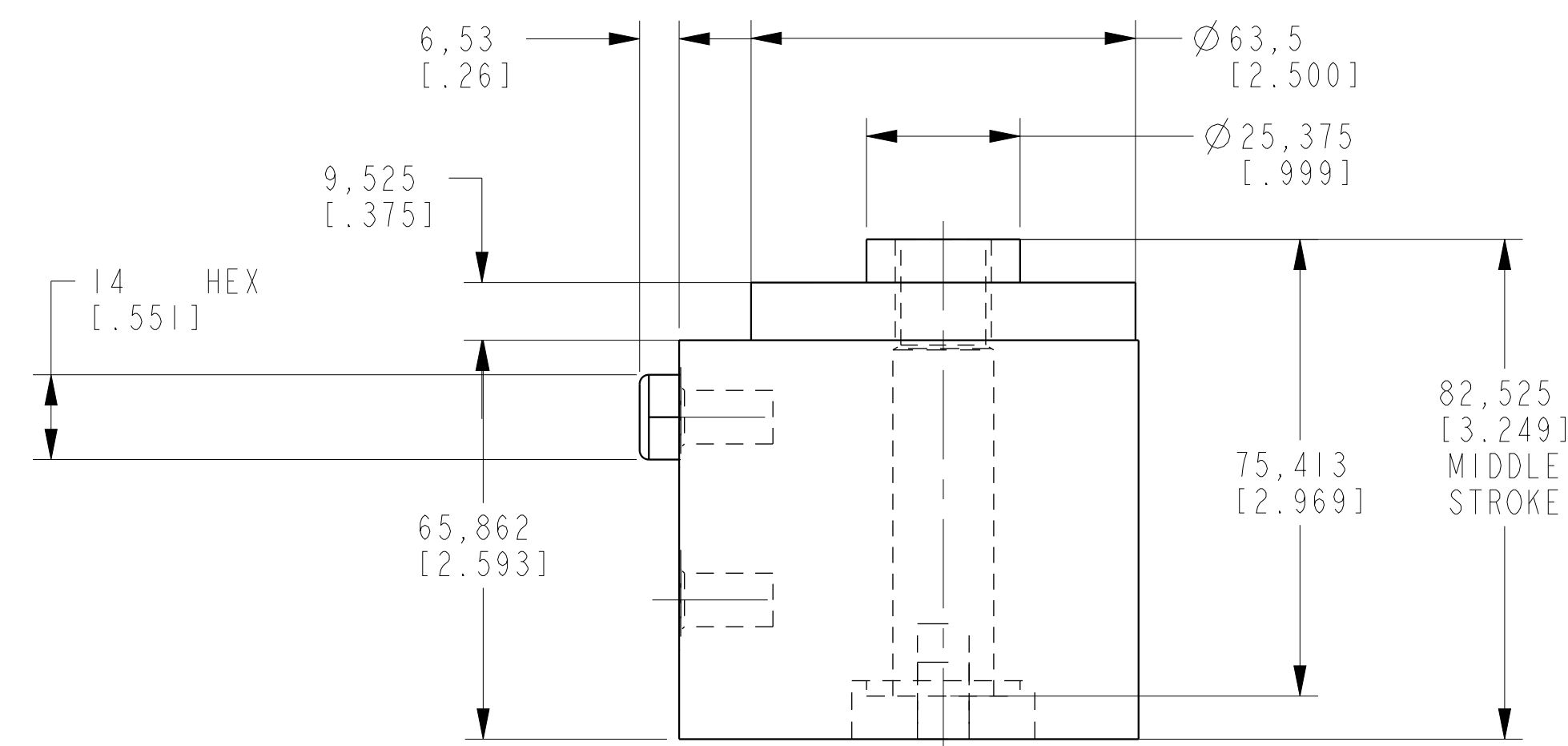
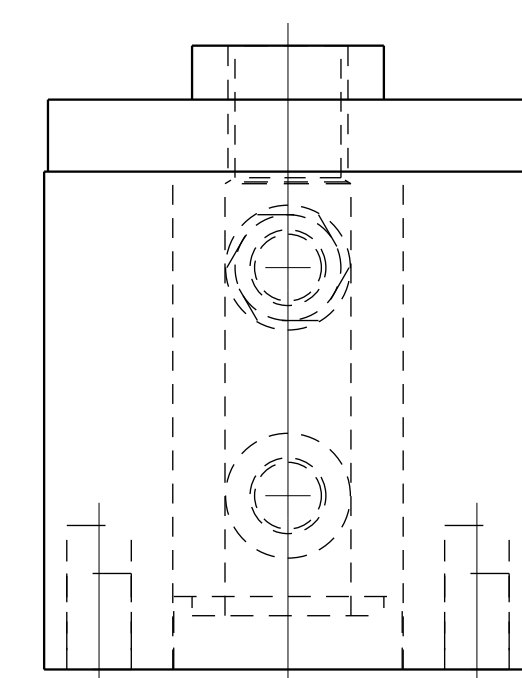

CAD CONTROL DRAWING

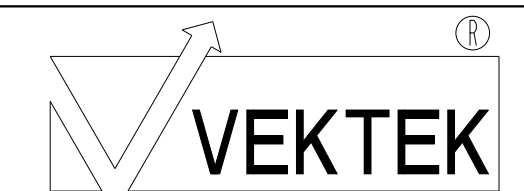

VEKTEK, INC.
1334 E. SIXTH AVE. P.O. BOX 625
EMPORIA, KS. 66801 U.S.A.

B	3531	RELEASE	NPETERS	07/17/18	42021002	L	CYL, HR, 53.2 KN, SA
REV	IN ACCORDANCE WITH ECN	EFFECTIVE DATE	REVISED BY	DATE	REFERENCE MODEL	REF REV	---
DRW BY:	K. ROEMER	DRAWING STATUS: Released			TOLERANCES DO NOT APPLY	UNITS	SIZE
DATE:	05-26-06	PRODUCTION APPROVED FOR RELEASED STATUS ONLY			DIMENSIONS ARE NOMINAL	mm (inch)	D
					ILCM42021002	REV	B

1

2

3

4

SHEET 1 OF 1