

1/8 BSPP HYDRAULIC  
PRESSURE OUTLET PORT  
ON CENTERLINE

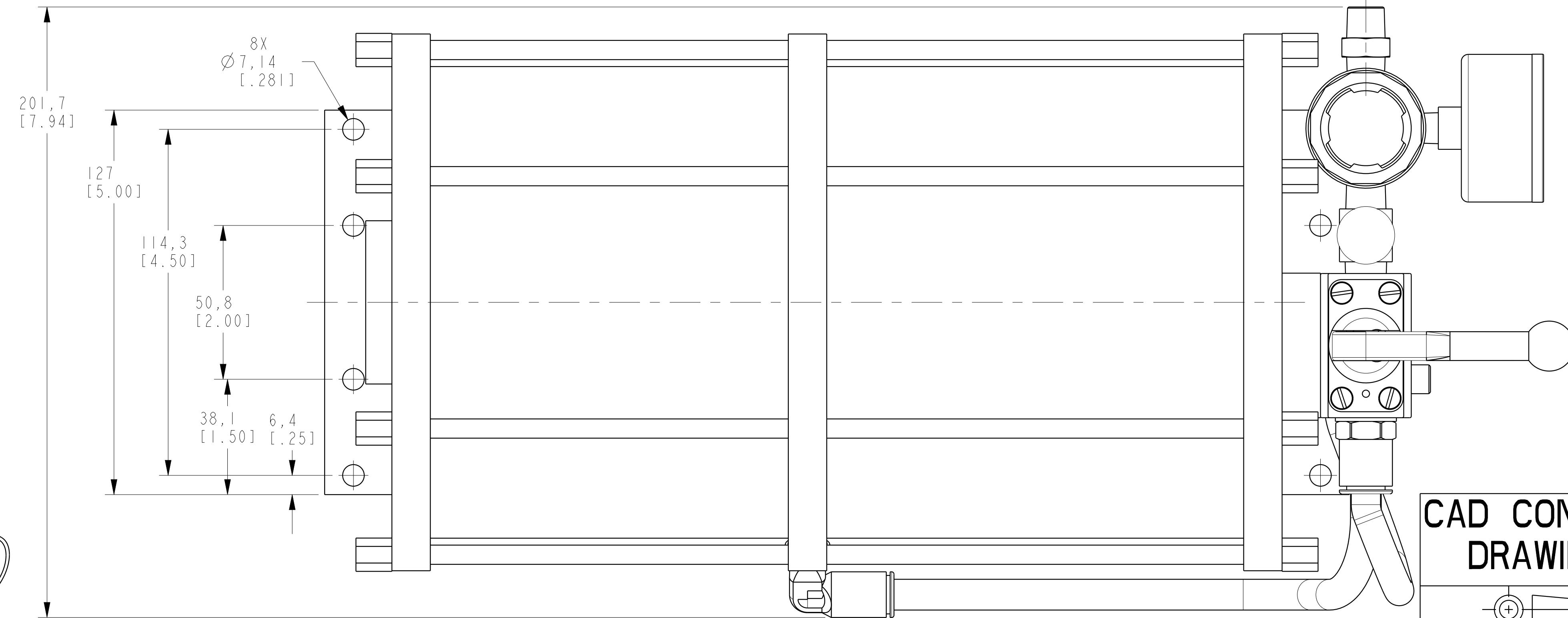

CAD CONTROL  
DRAWING

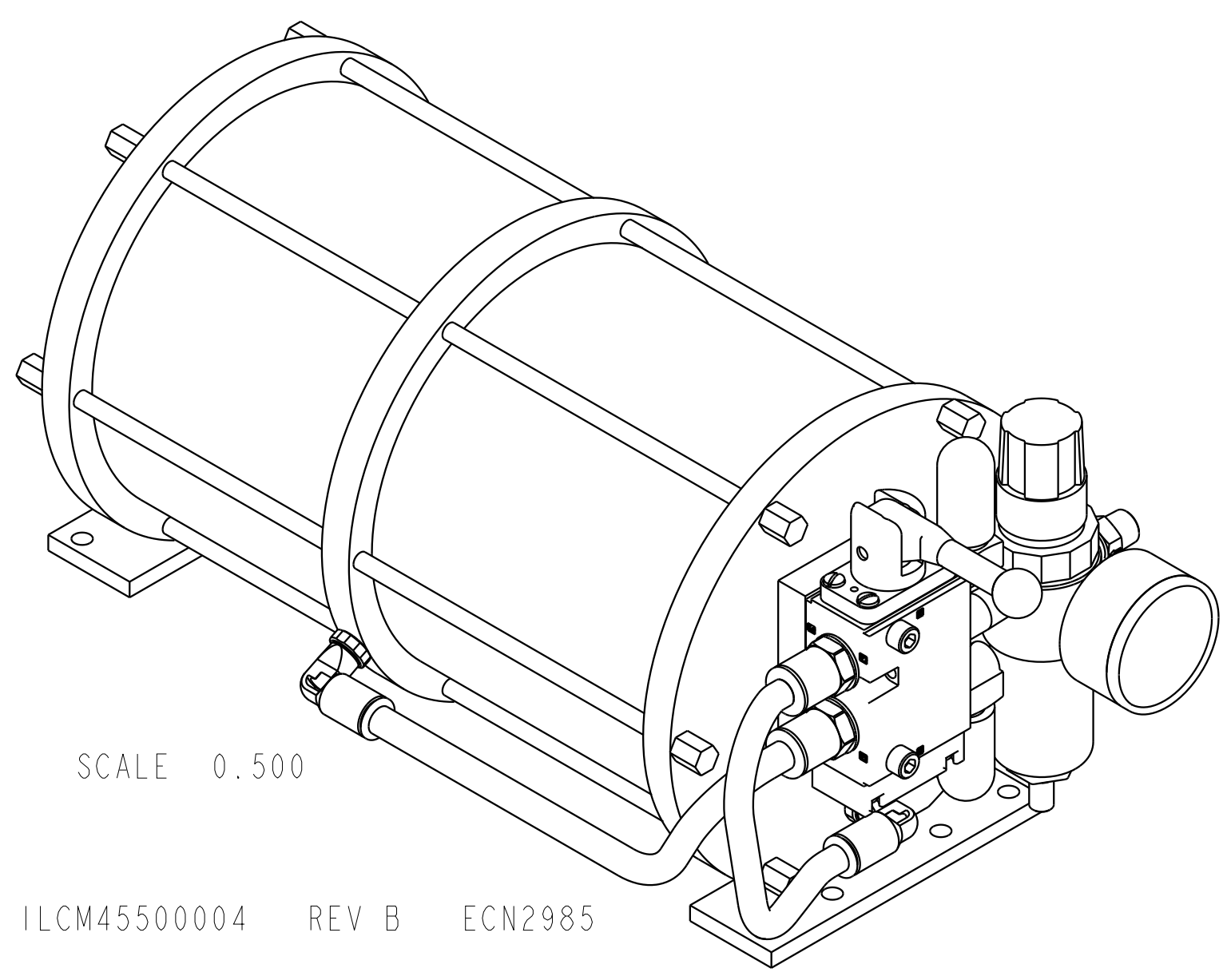
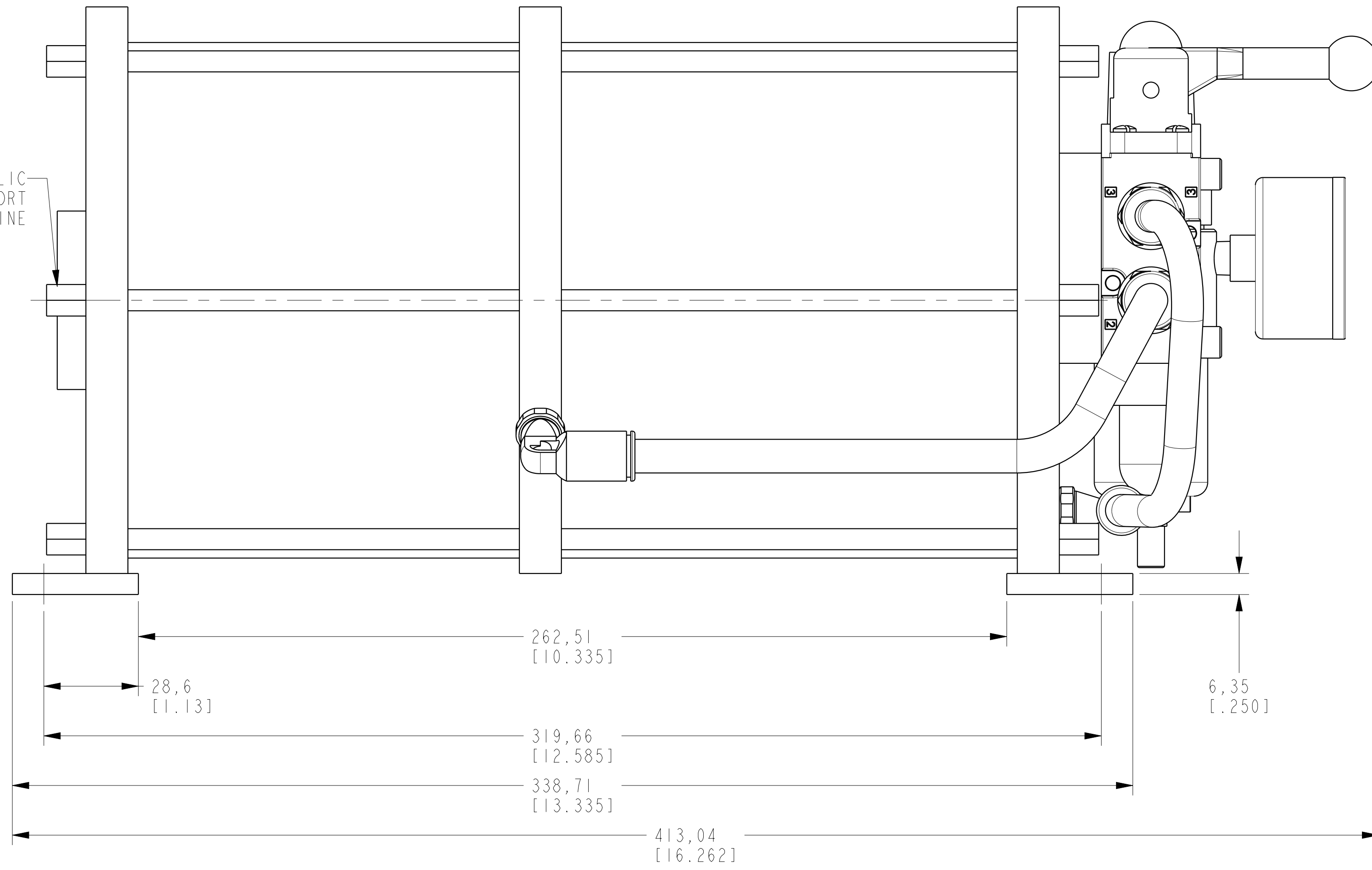
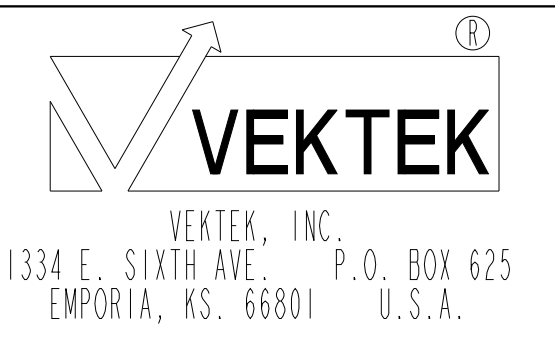

B	2985	RELEASE	TWA	2/23/16	45500004	H	BOOSTER, A/H, 22:1, MNL
REV	IN ACCORDANCE WITH ECN	EFFECTIVE DATE	REVISED BY	DATE	REFERENCE MODEL	REF REV	*****
DRW BY:	K. ROEMER	DRAWING STATUS: Released			TOLERANCES DO NOT APPLY	UNITS	SIZE
DATE:	05-30-06	PRODUCTION APPROVED FOR RELEASED STATUS ONLY			DIMENSIONS ARE NOMINAL	mm (inch)	D
							ILCM45500004
							REV B