

ILCM45600722 REV A ECN3570

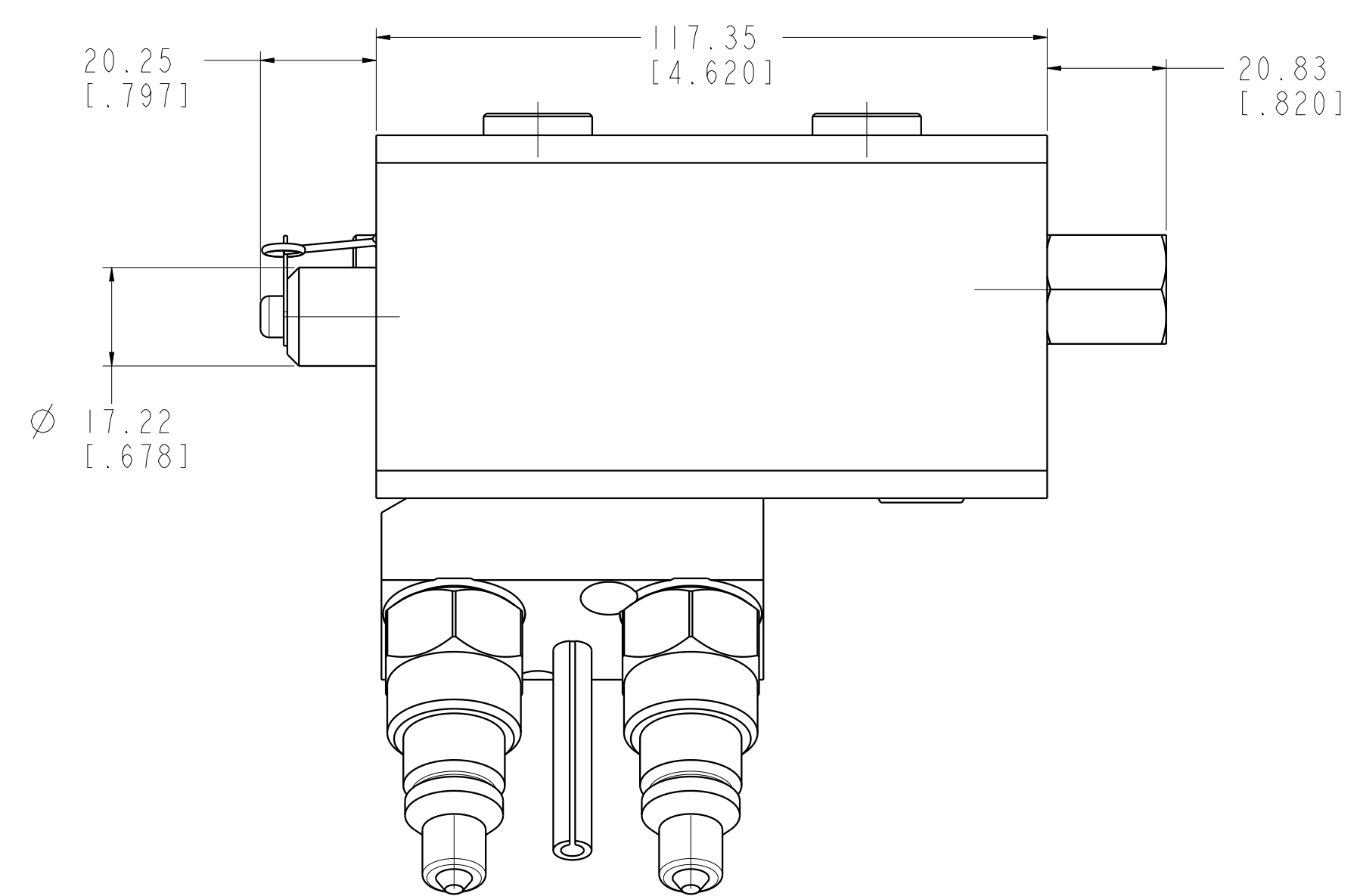
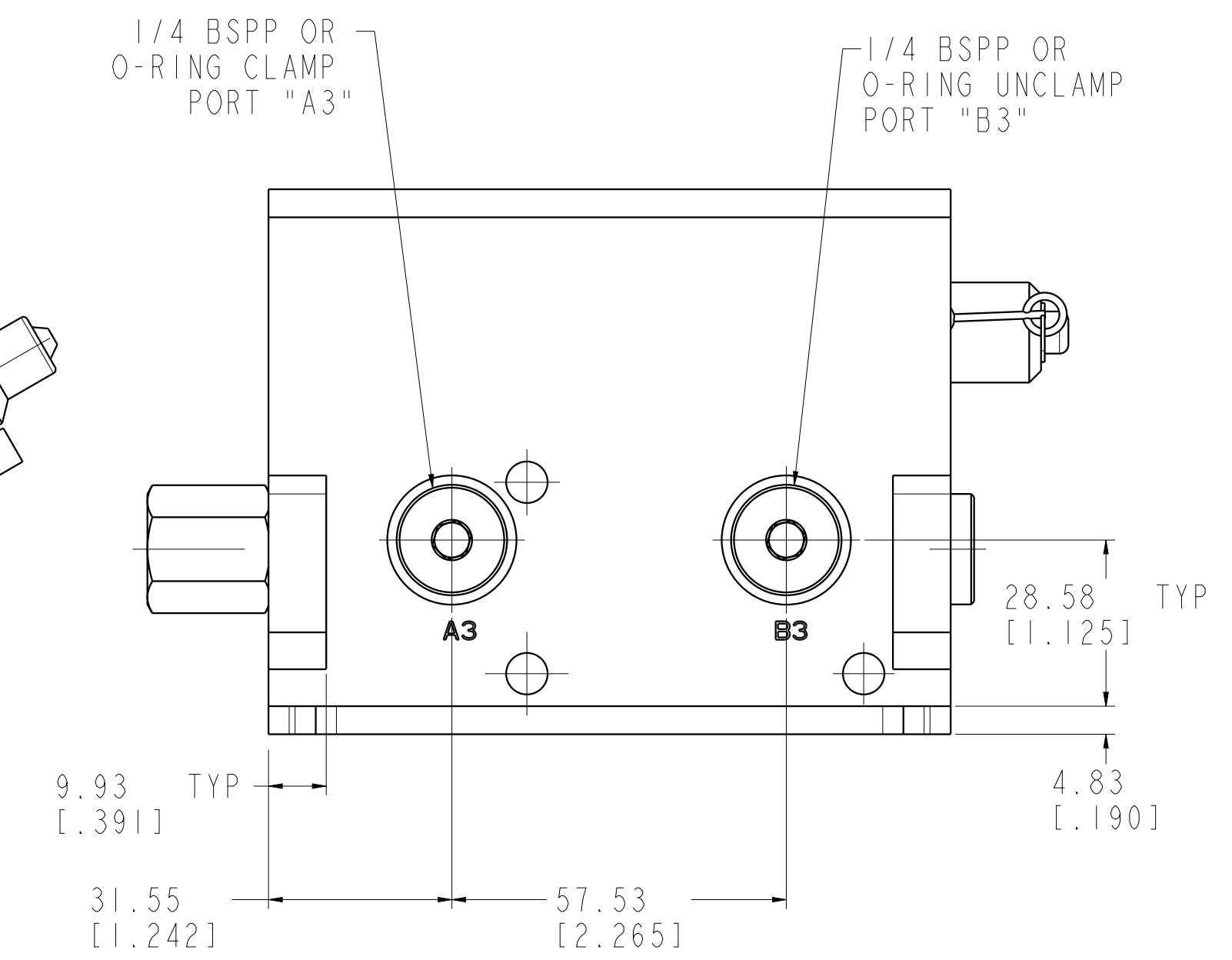
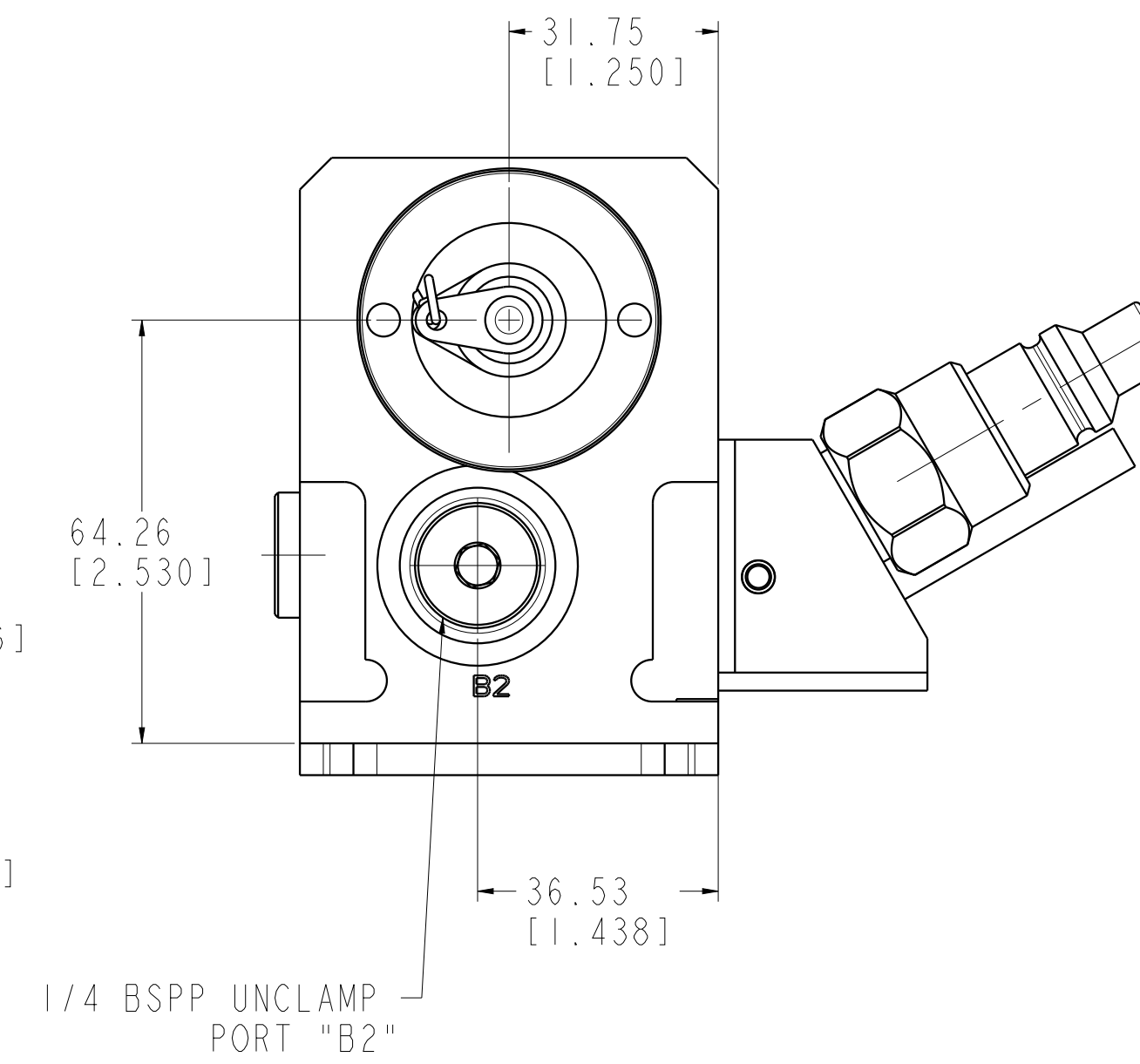
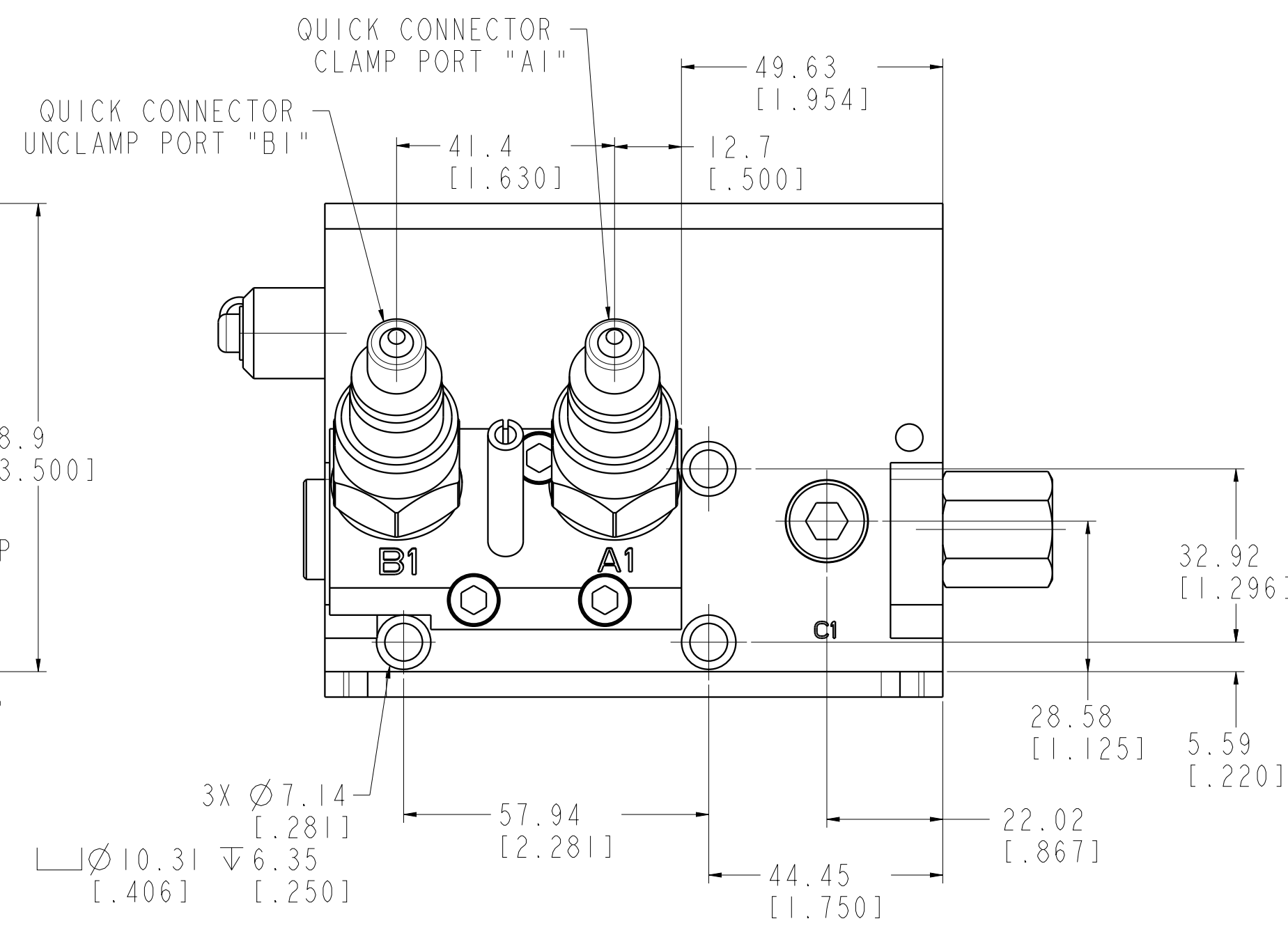
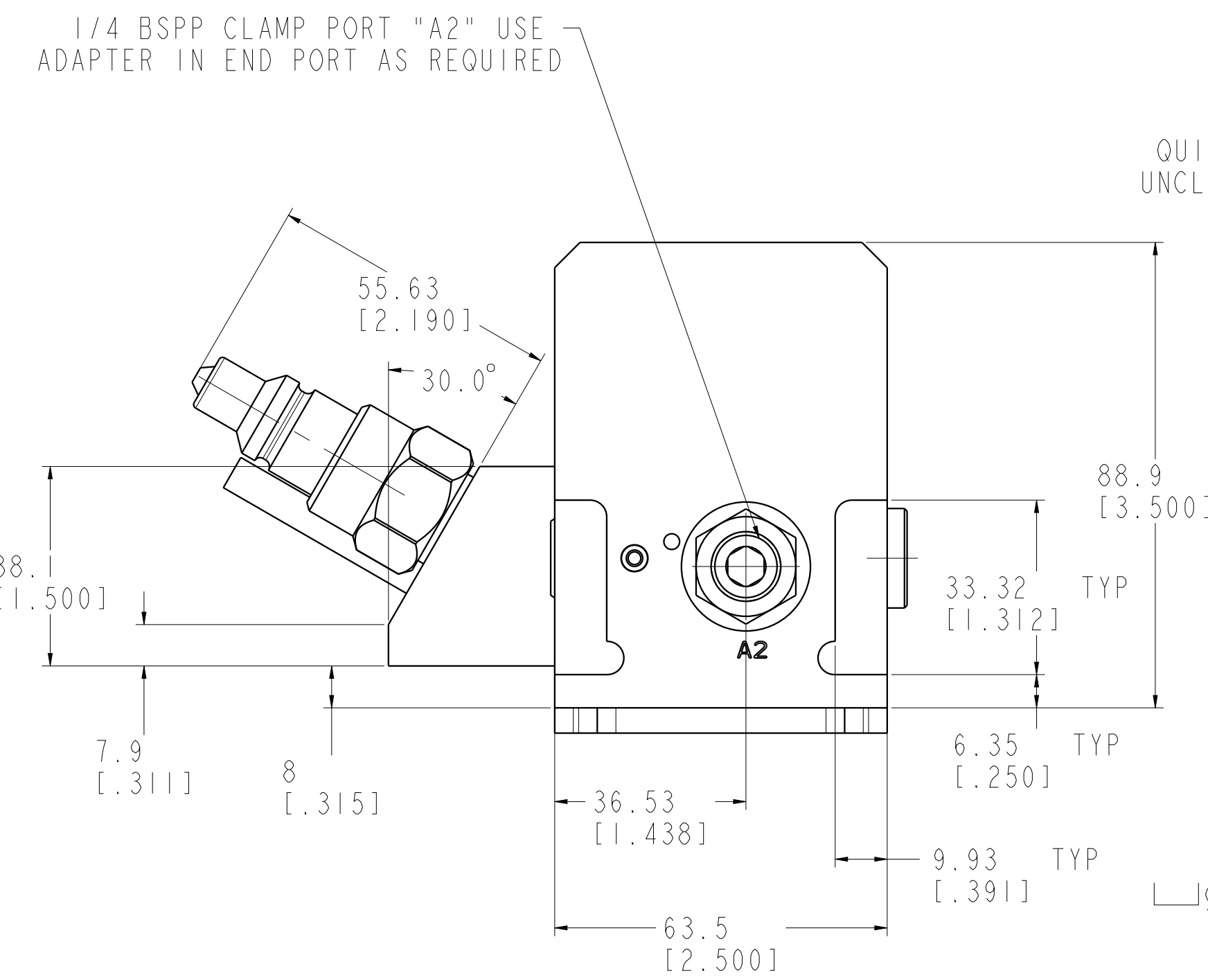

CAD CONTROL DRAWING

VEKTEK, INC.
1334 E. SIXTH AVE. P.O. BOX 625
EMPORIA, KS. 66801 U.S.A.

A	3570	RELEASE	DLG	8-29-18	45600722	A	ASSY, PD, IH, DUAL, 35 MPA, INT ACC
REV	IN ACCORDANCE WITH ECN	EFFECTIVE DATE	REVISED BY	DATE	REFERENCE MODEL	REF REV	*****
DRW BY:	DLG	DRAWING STATUS: Released			TOLERANCES DO NOT APPLY	UNITS	SIZE
DATE:	8/2/18	PRODUCTION APPROVED FOR RELEASED STATUS ONLY			DIMENSIONS ARE NOMINAL	mm (inch)	D
							ILCM45600722
							REV A