

ILCMV41621820 REV A ECN 4724

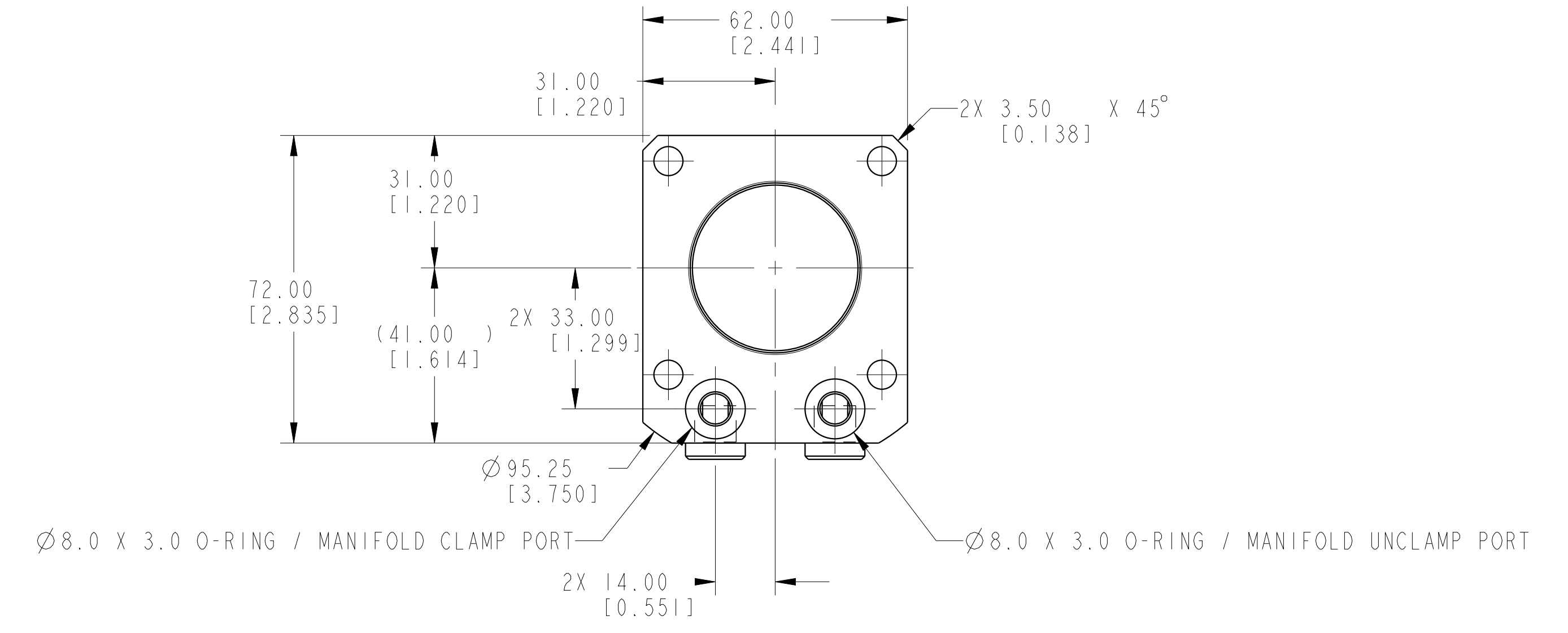
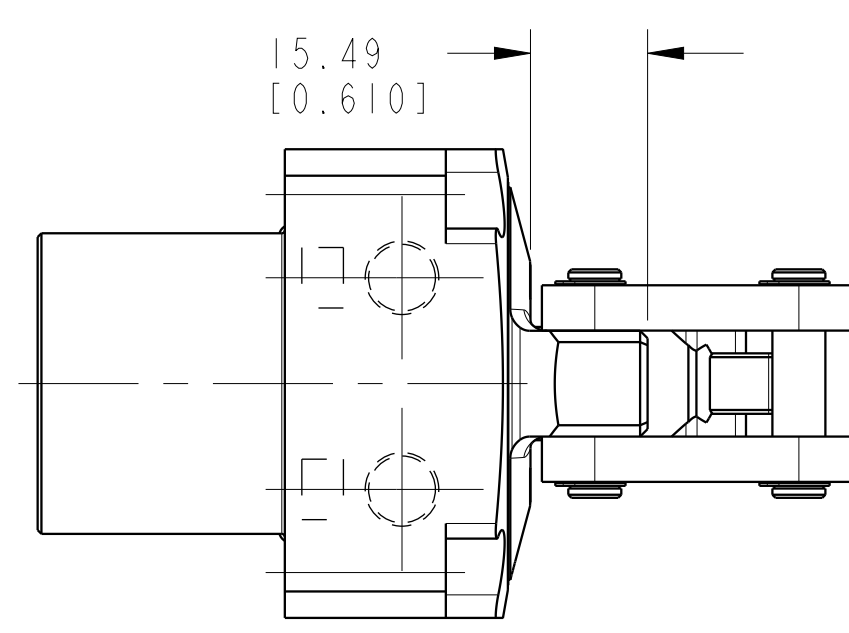
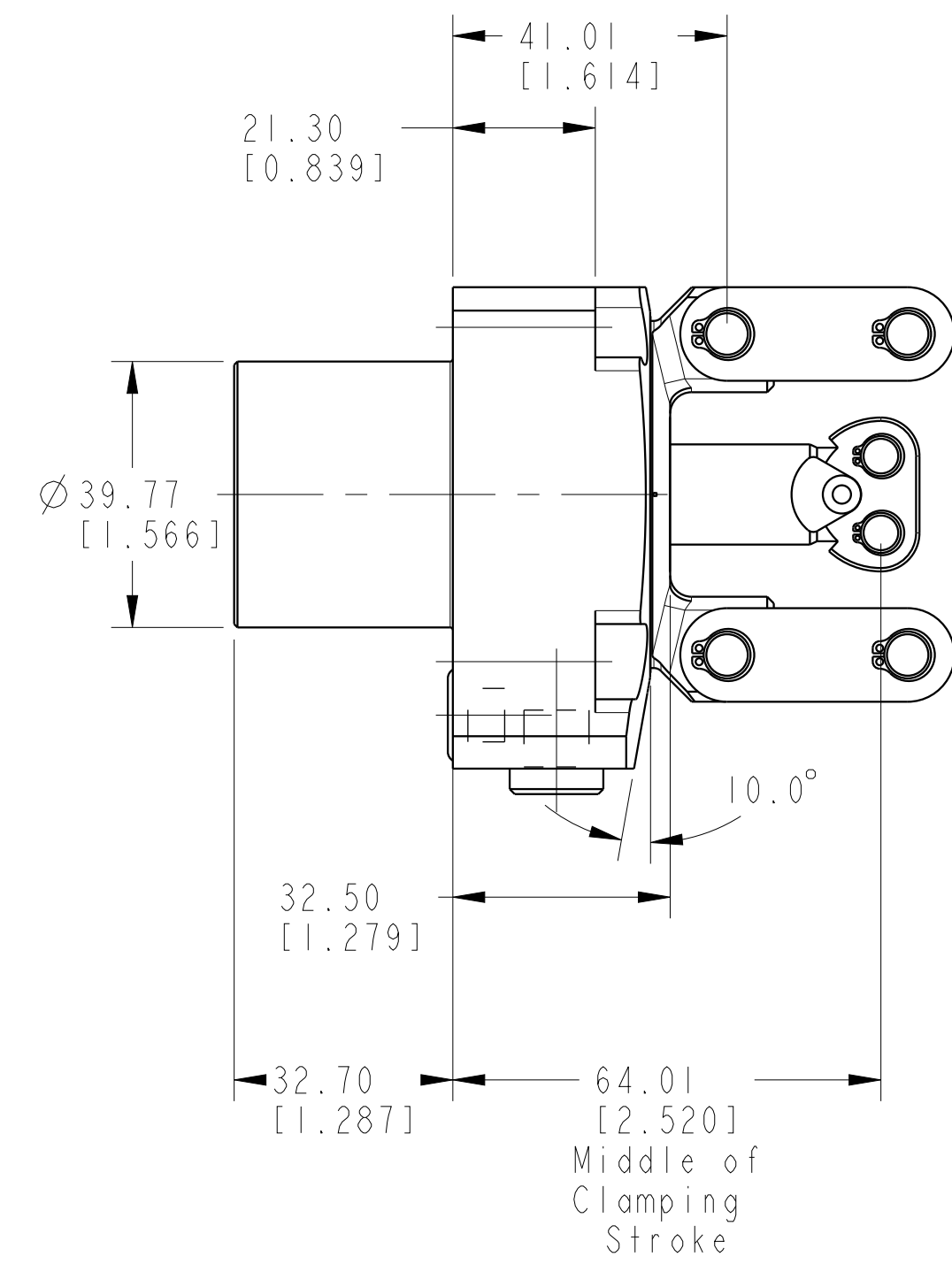
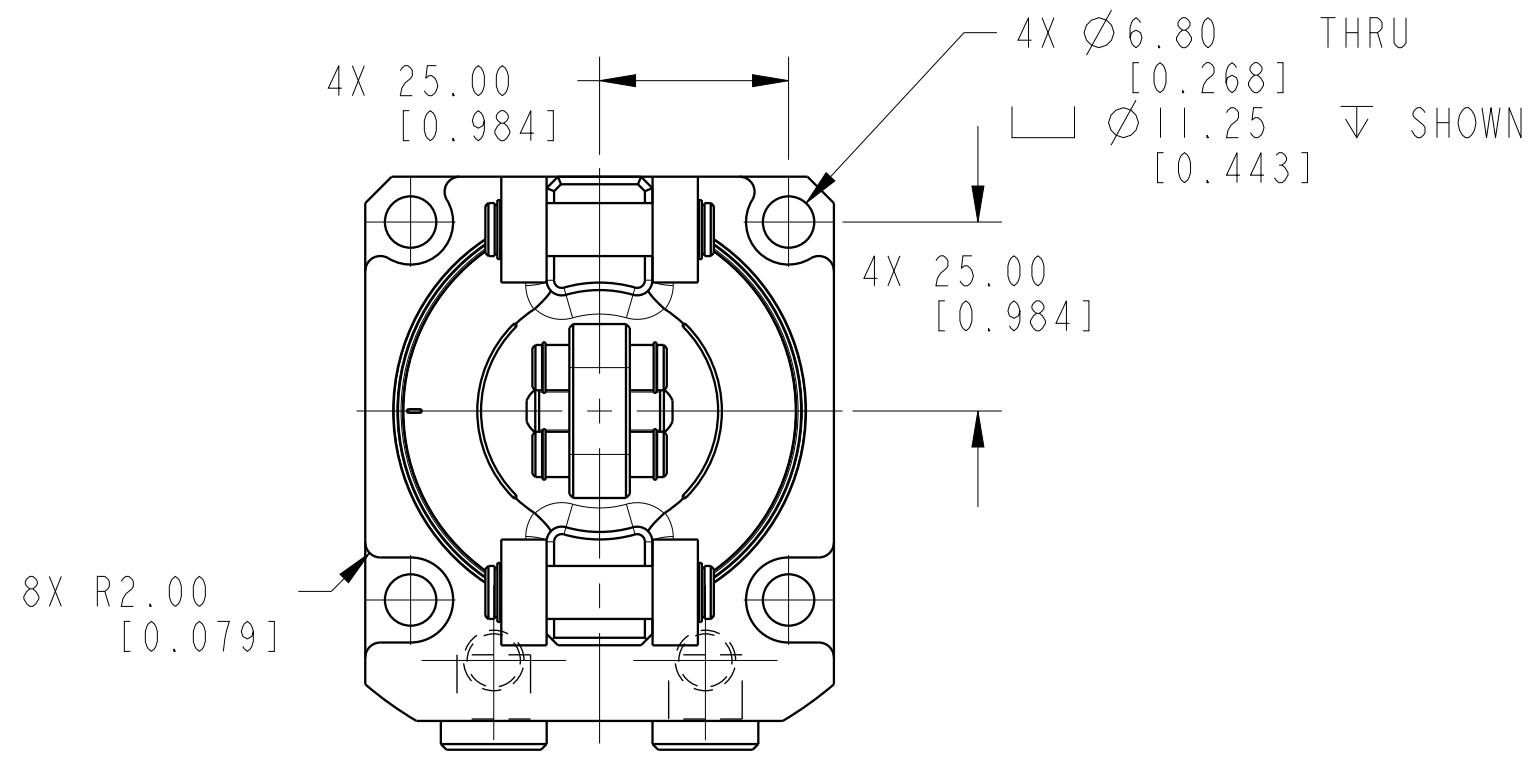

CAD CONTROL DRAWING		
	VEKTEK, INC. 1334 E. SIXTH AVE. P.O. BOX 625 EMPORIA, KS. 66801 U.S.A.	

A	4724	RELEASE	BDC	7/20/22	41621800	A	LC, TL360, DA, 6.22kN
REV	IN ACCORDANCE WITH ECN	EFFECTIVE DATE	REVISED BY	DATE	REFERENCE MODEL	REF REV	
DRW BY:	BCD	DRAWING STATUS: Released			TOLERANCES DO NOT APPLY	UNITS	SIZE
DATE:	8-25-16	PRODUCTION APPROVED FOR RELEASED STATUS ONLY			DIMENSIONS ARE NOMINAL	mm (inch)	D
					ILCMV41621820	REV	A