

# 接头

## 6mm 管接头-最大压力250bar (25MPa)

43-0000-01  
接头, 直型, 6 mm

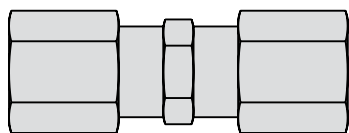

43-0000-03  
接头, 直型, 变径, 8-6 mm

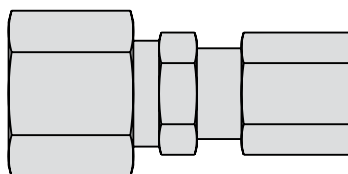

43-0000-04  
接头, 弯头, 6 mm

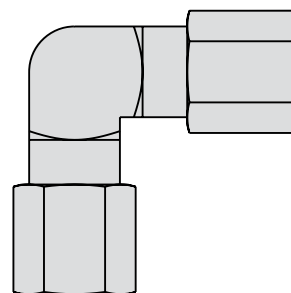

43-0000-08  
接头, 十字型, 6 mm

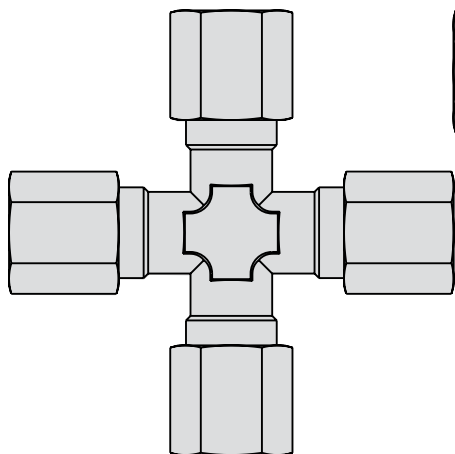

43-0000-06  
接头, T型, 6 mm

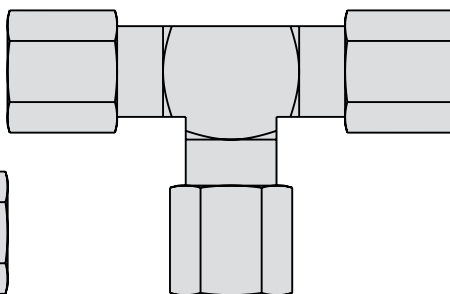

43-0000-17  
T型, 三通, 旋转,  
6 mm G1/8 双头螺柱

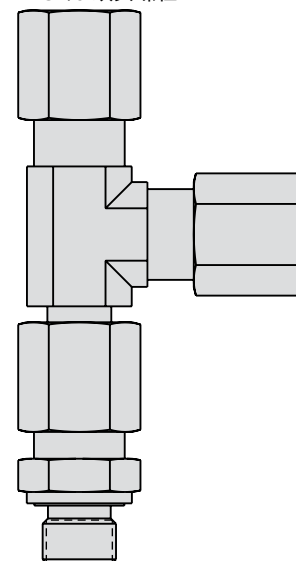

43-0000-10  
连接, 标准,  
6 mm-G1/8  
双头螺柱

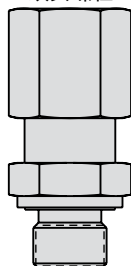

43-0000-11  
连接, 标准,  
8 mm-G1/8  
双头螺柱

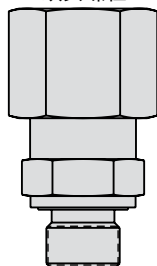

43-0000-13  
弯头, 旋转,  
6 mm-G1/8 双头螺柱

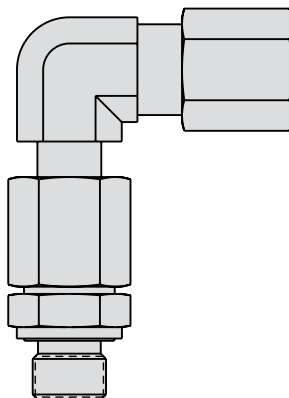

43-0000-15  
T型, 分流, 旋转,  
6 mm-G1/8 双头螺柱

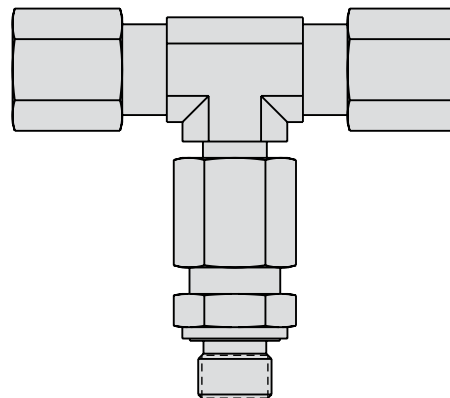

ILMV430040 REV A



## 8mm 管接头-最大压力350bar (35MPa)

43-0000-02  
接头, 直型, 8 mm

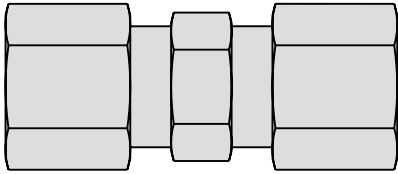

43-0000-05  
接头, 弯头, 8 mm

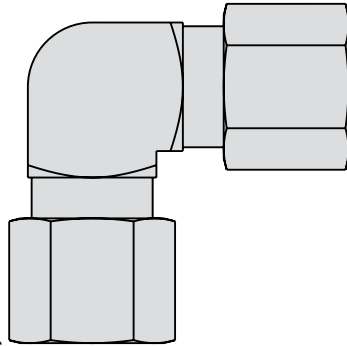

43-0000-07  
接头, T型, 8 mm

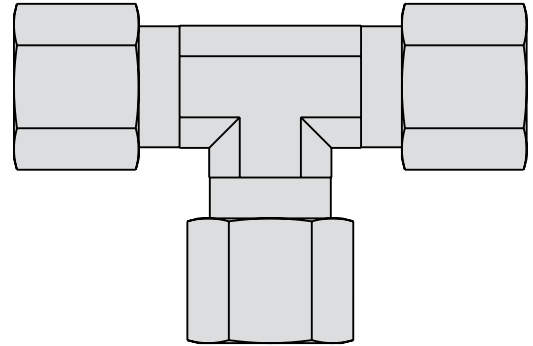

43-0000-16  
T型, 分流, 旋转,  
8 mm-G1/4 双头螺柱

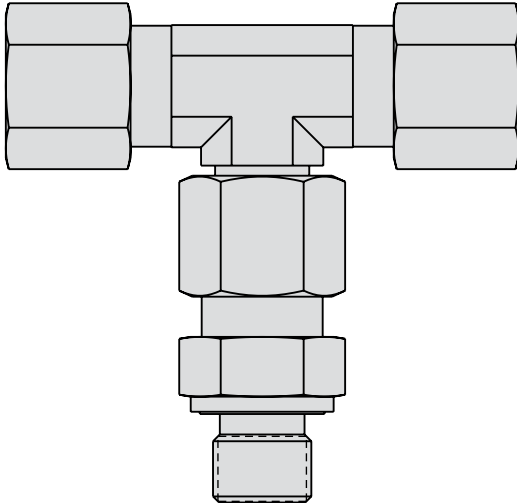

43-0000-09  
接头, 十字型, 8 mm

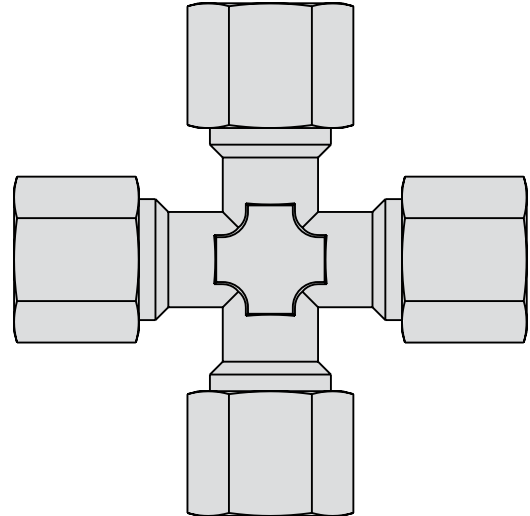

H-2

43-0000-12  
连接, 标准,  
8 mm-G1/4 双头螺柱

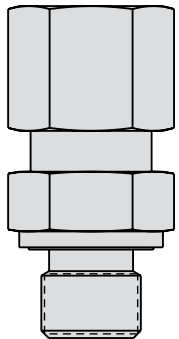

43-0000-14  
弯头, 旋转,  
8 mm-G1/4 双头螺柱

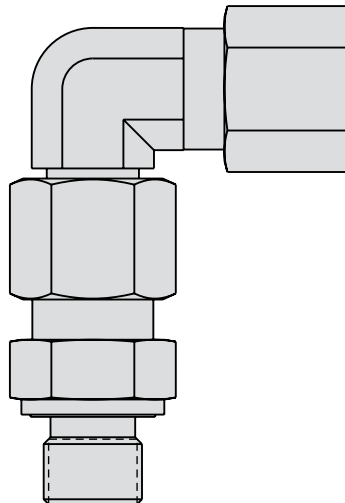

43-0000-18  
T字型, 三通, 旋转,  
8 mm-G1/4 双头螺柱

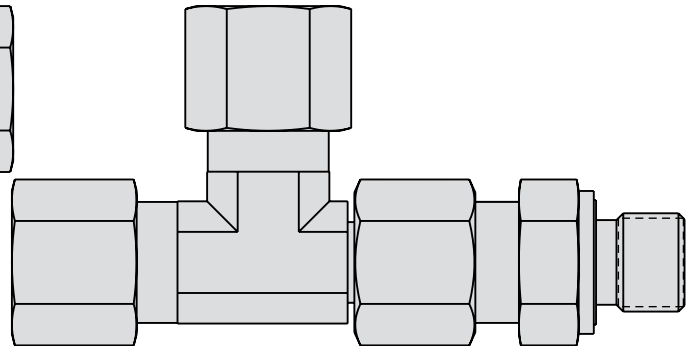

ILMV430041 REV B

# 接头

## 转换接头、延长接头、堵头和密封圈

43-0000-19  
转换接头, 变径,  
外丝 G1/8-内丝 G1/4

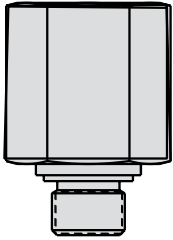

43-0000-20  
转换接头,  
外丝 G1/4-  
内丝 1/4 NPT

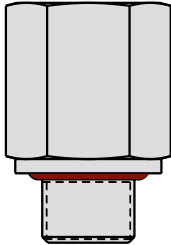

43-0000-21  
延长型, 外丝 G1/4-  
内丝 G1/4x35 mm

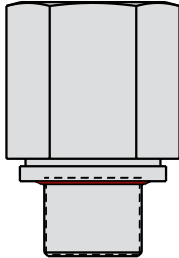

43-0000-22  
延长型, 外丝 G1/4-  
内丝 G1/4x59 mm



43-0000-23  
转换接头,  
外丝 SAE 4-  
内丝 G1/8

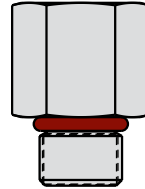

43-0000-24  
转换接头,  
外丝 SAE 6-  
内丝 G1/4

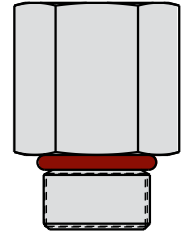

30-8782-44  
外丝 G1/8 -  
内丝 SAE 4

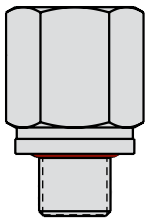

30-8782-64  
外丝 G1/4 -  
内丝 SAE 4

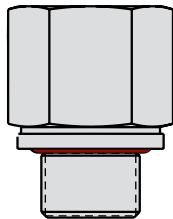

43-0000-25  
螺母, 管式,  
6 mm

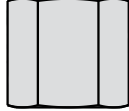

43-0000-26  
螺母, 管式,  
8 mm

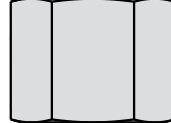

43-0000-27  
卡套, 切削,  
6 mm



43-0000-28  
卡套, 切削,  
8 mm



43-0680-04  
堵头,  
G1/8

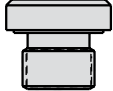

43-0680-06  
堵头,  
G1/4

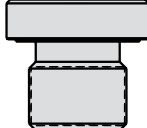

43-0000-31  
密封圈, 弹性,  
G1/8



43-0000-32  
密封圈, 弹性,  
G1/4



43-0000-29  
卡套,  
管式, 6 mm

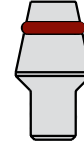

43-0000-30  
卡套,  
管式, 8 mm

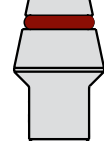

39-0550-06  
密封圈, 粘合,  
G1/8

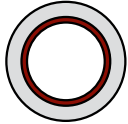

39-0500-05  
密封圈, 粘合,  
G1/4

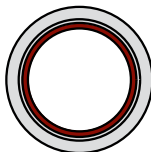

ILMV430042 REV C

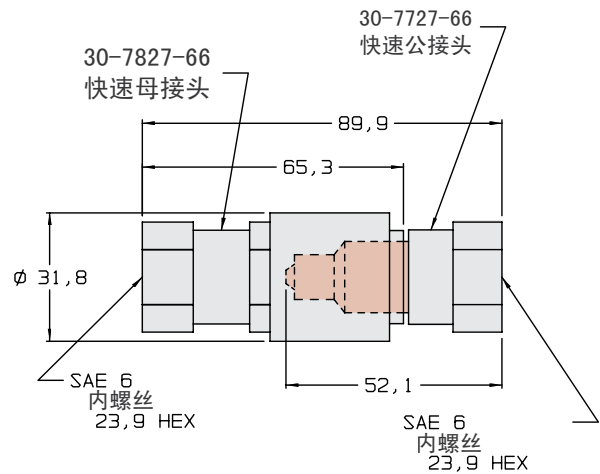

ILMV307700 REV A

H-3

