

杠杆缸，压板

杠杆缸压板尺寸

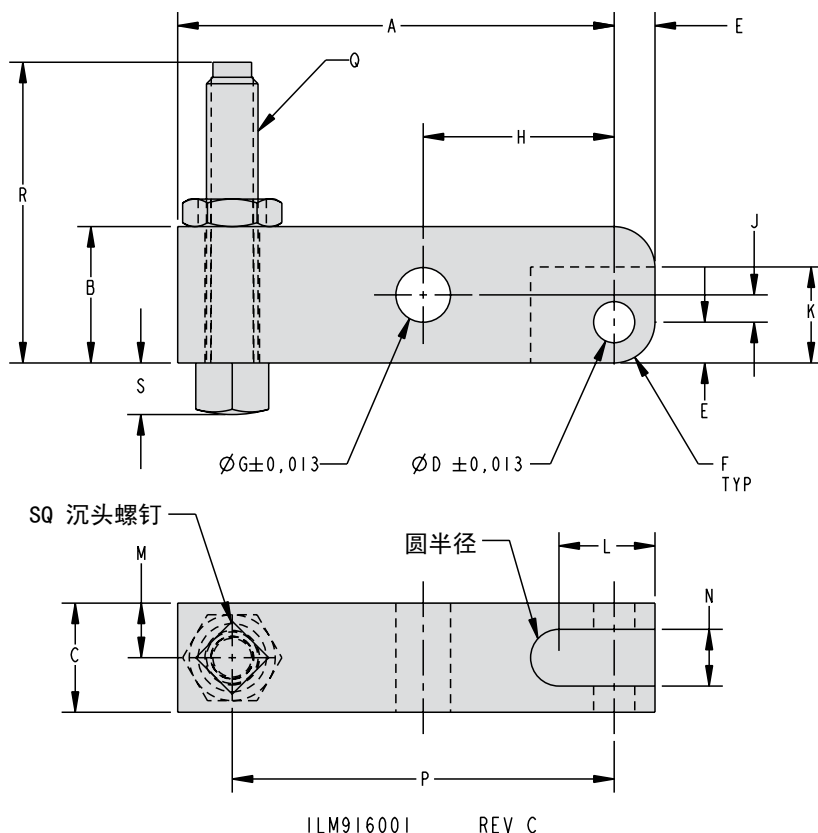

尺寸

型号	缸夹紧力 SA (kN)	缸夹紧力 DA (kN)	A	B	C	D	E	F	G	H	J
标准长度压板，比例为1:1											
91-6004-03	1.5	2	50.8	16.0	12.7	4.788	4.8	4.8	6.363	22.2	3.2
91-6006-03	3	5	63.5	22.4	16.0	6.388	6.4	6.4	9.538	28.6	3.2
91-6009-03	6	11	79.5	31.8	25.4	9.563	9.5	9.7	12.713	34.9	4.7
91-6014-03	13	22	101.6	44.5	31.8	12.738	12.7	12.7	15.888	44.5	6.4
无螺纹孔加长压板，比例为2:1											
91-6004-02	1.5	2	73.2	16.0	12.7	4.788	4.8	4.8	6.363	22.2	3.2
91-6006-02	3	5	92.2	22.4	16.0	6.388	6.4	6.4	9.538	28.6	3.2
91-6009-02	6	11	114.3	31.8	25.4	9.563	9.5	9.7	12.713	34.9	4.7
91-6014-02	13	22	146.1	44.5	31.8	12.738	12.7	12.7	15.888	44.5	6.4
型号	缸夹紧力 SA (kN)	缸夹紧力 DA (kN)	K	L	M	N	P	Q	R	S	
标准长度压板，比例为1:1											
91-6004-03	1.5	2	11.2	11.2	6.4	6.6	44.5	M6 x 1	36.8	6.0	
91-6006-03	3	5	14.2	14.2	7.9	8.1	57.2	M8 x 1.25	42.3	8.0	
91-6009-03	6	11	20.6	20.6	12.7	13.0	69.9	M10 x 1.50	62.8	10.0	
91-6014-03	13	22	30.2	30.2	16.0	16.0	88.9	M12 x 1.75	83.3	12.0	
无螺纹孔加长压板，比例为2:1											
91-6004-02	1.5	2	11.2	11.2	6.4	6.6	N/A	N/A	N/A	N/A	
91-6006-02	3	5	14.2	14.2	7.9	8.1	N/A	N/A	N/A	N/A	
91-6009-02	6	11	20.6	20.6	12.7	13.0	N/A	N/A	N/A	N/A	
91-6014-02	13	22	30.2	30.2	16.0	16.0	N/A	N/A	N/A	N/A	

P-5



杠杆缸压板输出曲线

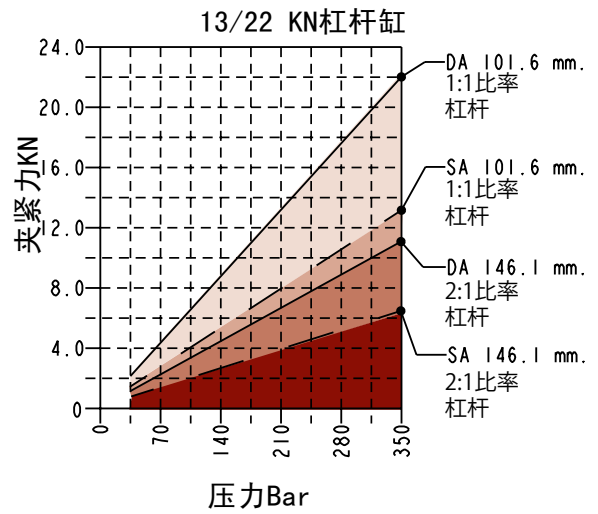
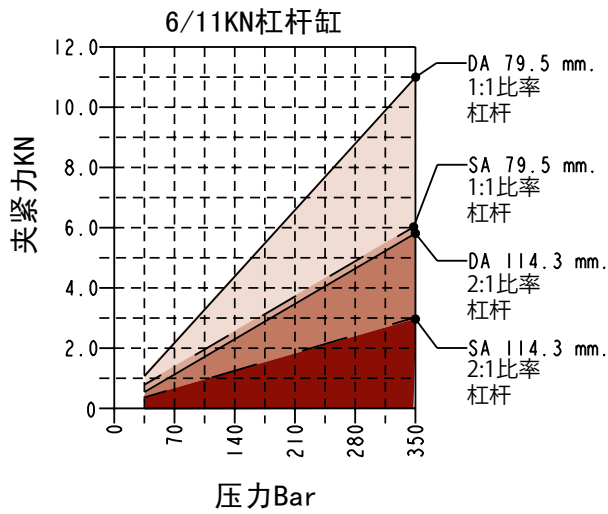
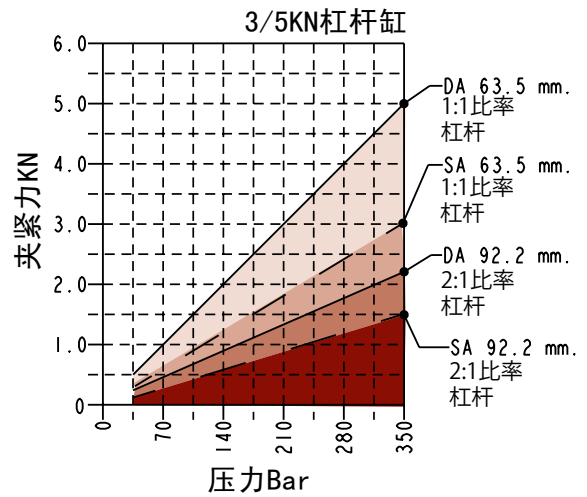
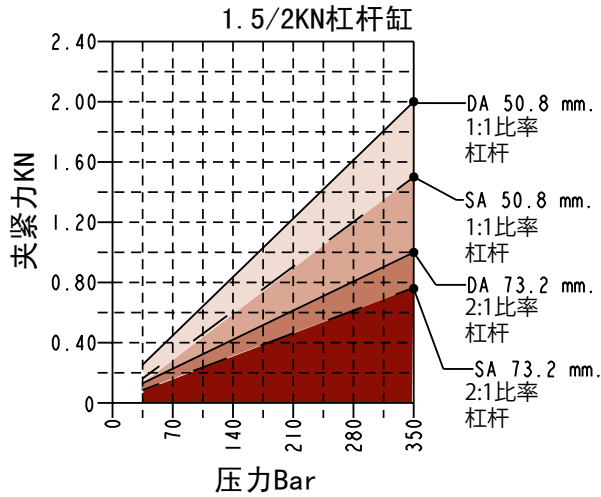

双作用 —————
单作用 - - - - -

ILM916002 REV B

说明：修改压板致使夹紧比例小于1:1，不在对应杠杆缸安全运行区内，会导致缸过早破坏。



杠杆缸，压板

偏心杠杆缸压板输出曲线

在使用偏心杠杆缸压板时，使用所示的曲线图作为指导，以确保杠杆缸在安全可用范围内运行。当使用偏心压板时，杠杆缸必须减压。压板的偏心距离越大，需要降低的压力越多。

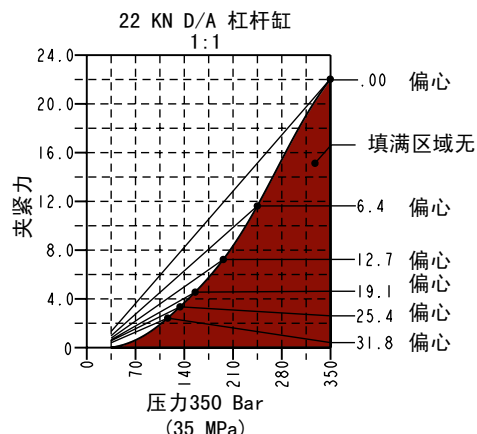
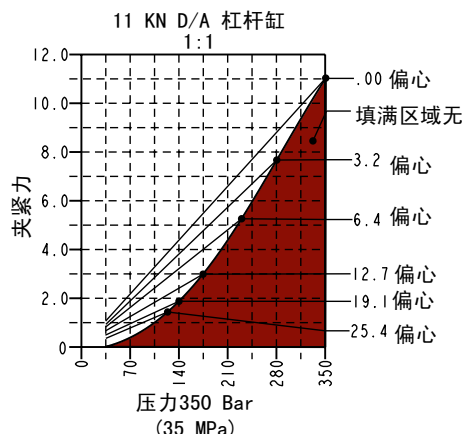
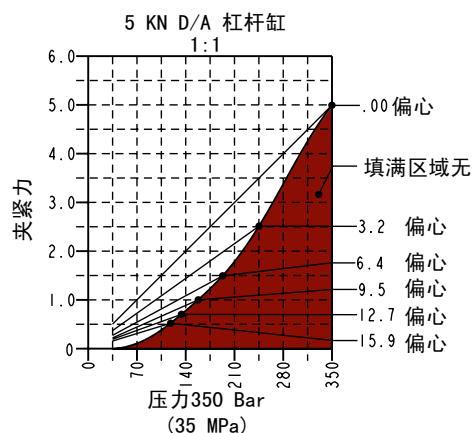
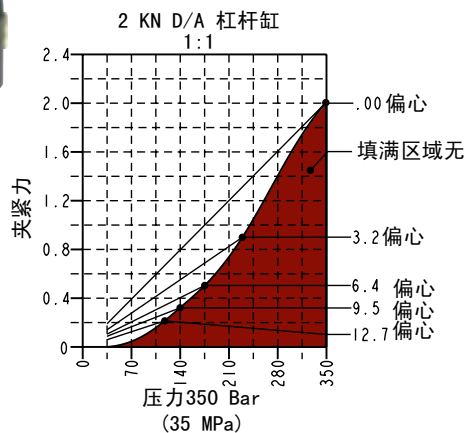
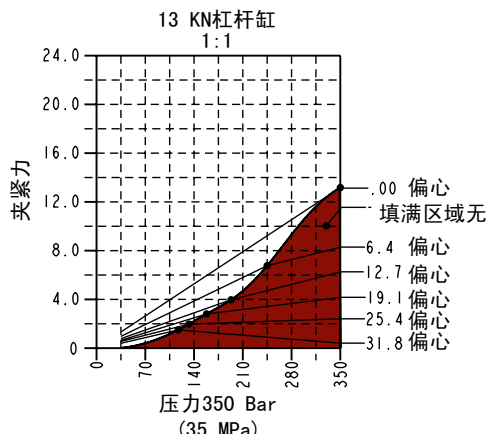
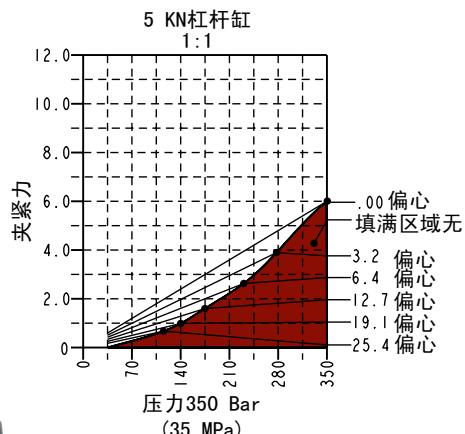
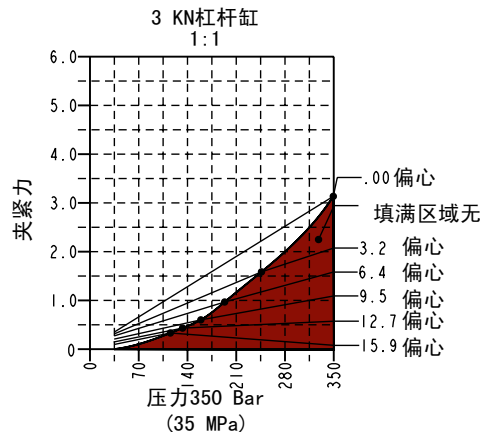
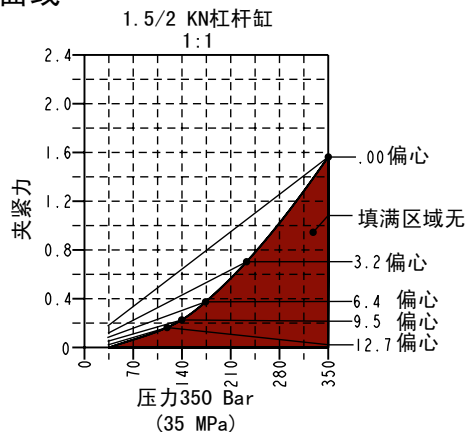

说明：对压板的修改导致夹紧比率在1:1 之下，不在相应的杠杆缸的安全操作范围内，将导致过早损坏。工作台的指定操作压力和过度的偏颈容许值将导致在杠杆夹销，连杆和活塞处产生过多压力，可能造成过早损坏。

ILMV916006 REV A